

- Programmable LED Driver
- Output Wattage: 60W
- Universal Voltage (120V-277V)
- CC Programmable 250-1050mA
- DALI Dimming
- Long Case and Terminal
- Output voltage range of 10-57VDC

General Specifications

Input Voltage	120-277VAC, 50/60 Hz
Input Current	0.6A@120V, 0.26A@277V
Input Power	72W
NTC Input	Ext. NTC Derating Resistance Range: 1k to 51k Ohm programmable. Default/Recommended Ext. NTC P/N: TSM2A204, SMD0805, Thinking Electronic
Power Factor	>0.9
THD	<20%
Efficiency	88% Typical@277V Full Load
Driver Type	Constant Current
Output Current	250-1050mA Programmable; See Label for Set Current; To program Use R-SET (Figure 1) or TPSB100 (Programmer); Record New Setting On 1" x 0.5" Label
Output Voltage Range	10-57VDC
Output Power	60W Max.
Number of Output Channels	1 Channel
Dimming Controller Type/Dimming Range	DALI / 100%-0% (Figure 2, Figure 3)
RFI/EMI	FCC Part 15B Consumer, EN55015
Output Type	LED Class 2
Ambient Operating Temperature Range	-40°C to 59°C (-40°F to 138.2°F)
Max. Case Temperature	85°C (185°F)
Sound Rating	A
Input Surge Protection	Line-Neutral 2kV, Line & Neutral-Ground 4kV
Protections	Input Current Protection
	Output Short Circuit Protection
	Output Open Circuit Protection
	Output to Ground Short Protection
	Overload Protection
Over Temperature Protection	Yes
Runtime Counting of Every 10 Degrees	Yes
Service Life	50,000 hours @Tc 82°C (179.6°F)
Approvals / Class	cURus, LED Class 2, Type TL, Dry or Damp Locations, CE, SELV, RoHS
Warranty	5 years

Figure 1

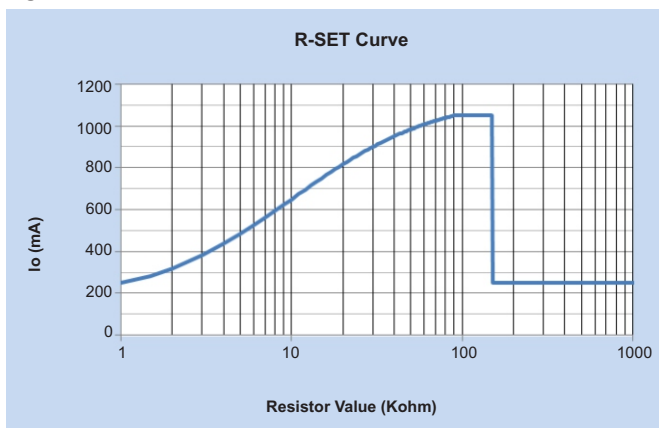
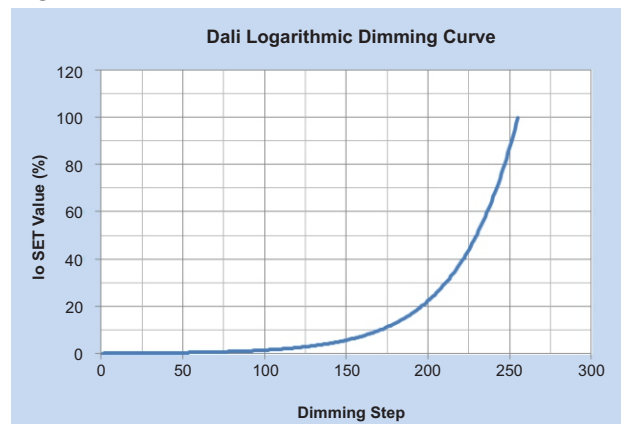

Figure 2



Fulham extends a limited warranty to the original purchaser or first user for a period of 5 years @ Tc 82C from the date of manufacture when properly installed and operated under normal conditions of use. For complete terms and conditions, please refer to the Warranty Center at www.fulham.com. Specifications subject to change without notice

Figure 3

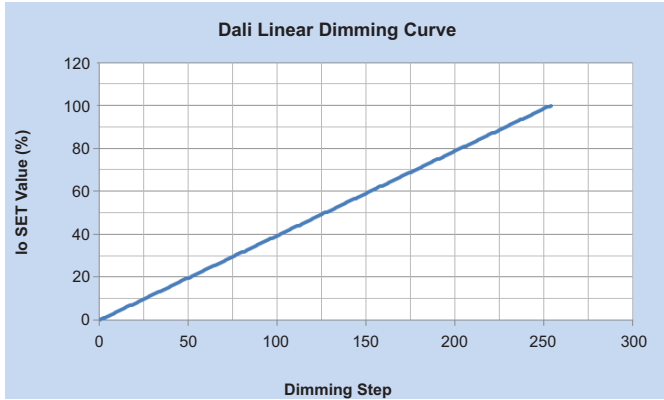

Figure 4

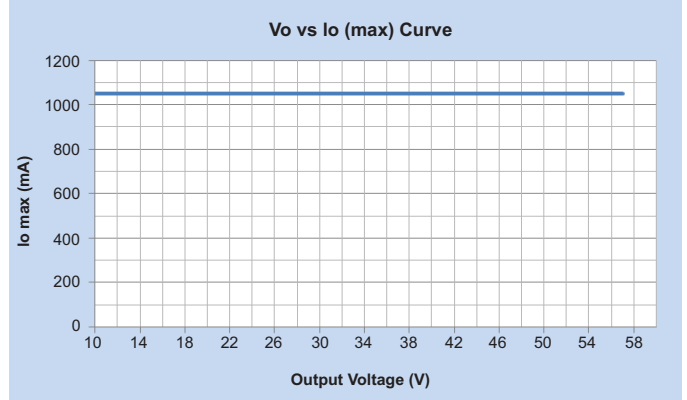

Figure 5

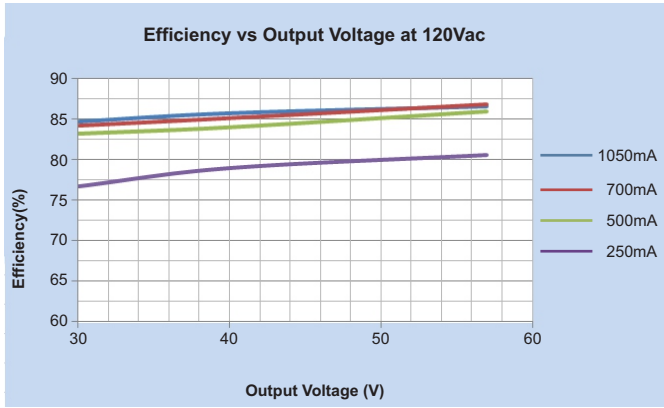

Figure 6

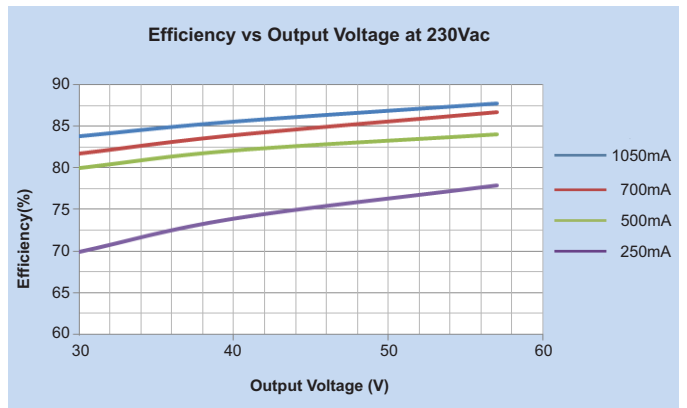

Figure 7

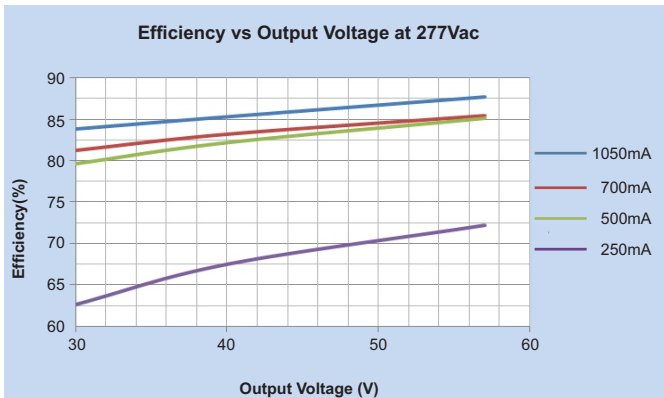

Figure 8

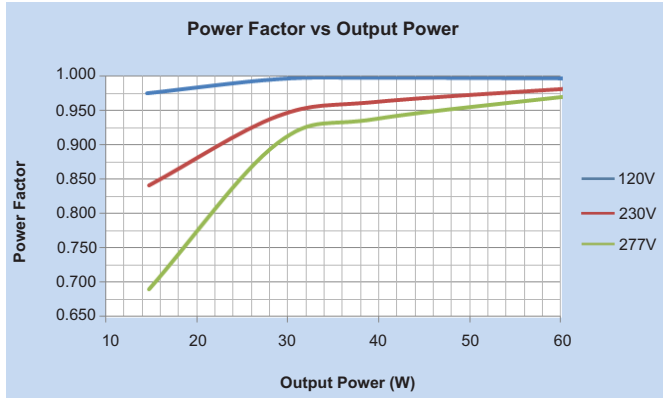

Figure 9

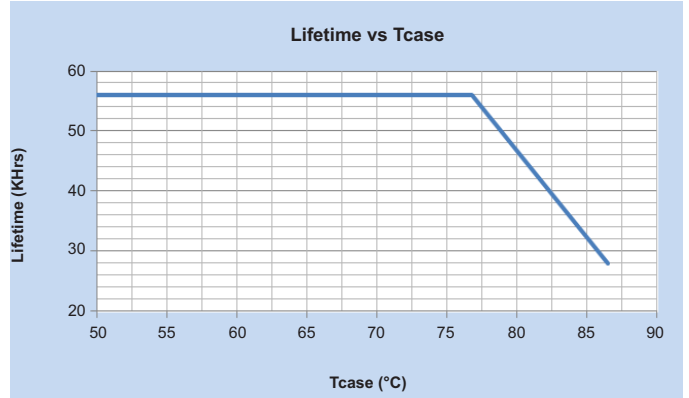

Figure 10

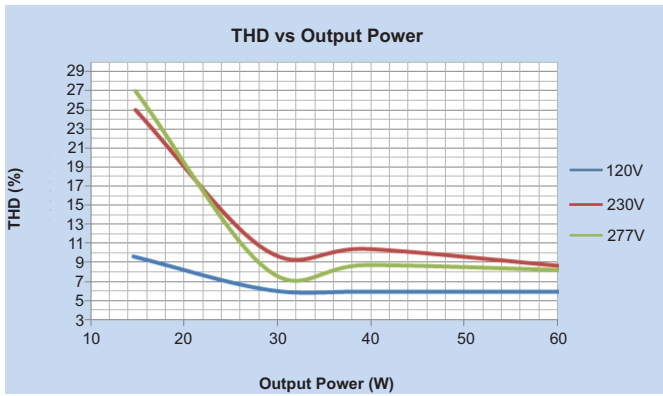

Figure 11

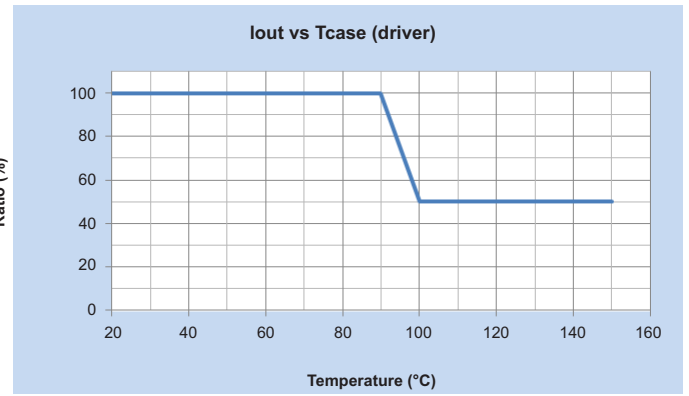
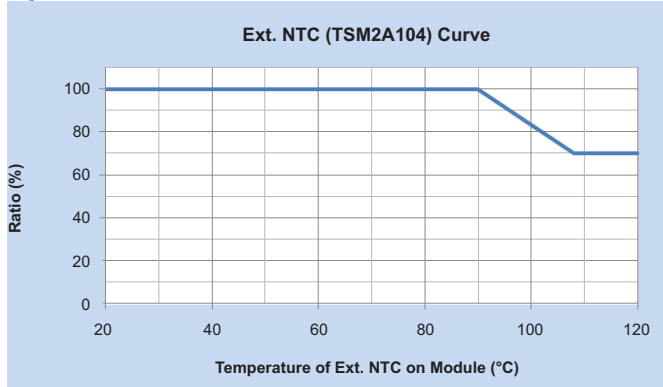
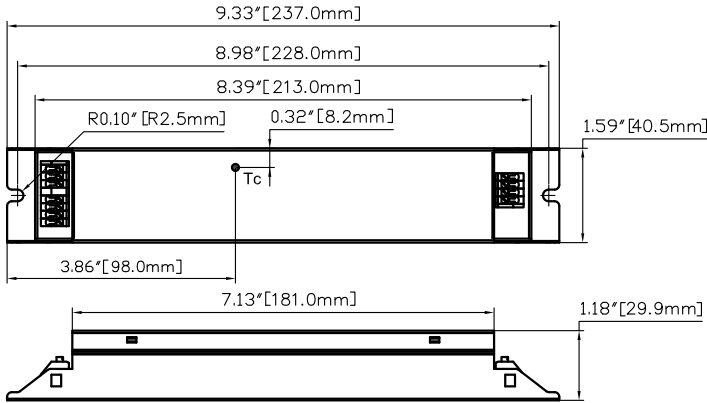

Figure 12



Mechanical Data

Where: L = Length, W = Width, H = Height, Tolerance=±0.02"



Wiring Diagrams

Note: This Driver Must Be Grounded

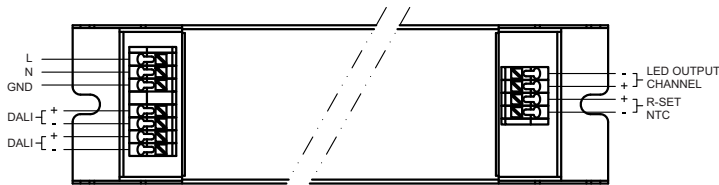

TPSB-100 Programming Controller

Please consult the user manual for instructions on using the TPSB-100 SmartSet programming controller

