

SPECIFICATION SHEET : RH4-UNV-242-BLS

This Is An Original Product From Fulham Co., Inc

Description : RACEHORSE Series, Universal Operating Voltage, Program Preheat Start Ballast, End Of Life Protection, Auto Restart, Cold Starting Feature.

This Ballast Will Operate Following Lamps.



TWIN(CFT/E), 4 PIN
24-27/36/40W/36TUV



QUAD (CFQ/E), 4 PIN
26W



TRIPLE(CFTR/E)
26W/32W/42W



2D28/38W



CFM57/70W



T5CR22/T5CR40

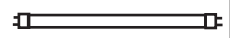

GPH793T5L

ELECTRICAL DATA (With 120 Volt Application-1 LAMP)

INPUT VOLT: 120V ± 10%, 50/60Hz											
LAMP WATTS/TYPE	CFM57	CFM70	42CFTR/E	24/27CFT/E	36CFT/E	40CFT/E	2D28W	2D38W	T5CR40	36TUV	GPH793T5L
LAMPS OPERATED	1										
INPUT WATTS	53.91W	75.06W	45.69W	26.89W	34.88W	47.39W	33.18W	32.14W	40.83W	33.73W	34.51W
LINE CURRENT:	0.442A	0.628A	0.382A	0.225A	0.292A	0.396A	0.278A	0.269A	0.341A	0.282A	0.289A
POWER FACTOR	0.998	0.996	0.998	0.996	0.996	0.997	0.995	0.995	0.997	0.997	0.995
BALLAST FACTOR	0.853	0.977	0.941	1.061	0.967	1.071	1.211	0.862	0.918	0.834	0.808
EFFICACY FACTOR	1.582	1.302	2.059	3.946	2.772	2.260	3.651	2.681	2.248	2.472	2.342
THD %	1.9%	3.7%	2.7%	6.5%	4.2%	1.8%	4.5%	4.8%	2.8%	4.3%	4.2%
CURRENT CREST FACTOR	1.5	1.6	1.5	1.5	1.4	1.4	1.5	1.5	1.5	1.6	1.6
EMI/RFI COMPLIANCE	FCC PART 18-B (Consumer)										
SOUND RATING	" A "										
BALLAST TYPE	PROGRAMMED START										
VOLTAGE TRANSIENTS	MOV (ANSI C82.11)										
INPUT/PROTECTION	FUSE										
OUTPUT/PROTECTION	OPEN LAMP, SHORTED LAMP, END-OF-LIFE										
MIN. OPERATING TEMP	-30 °C (-22 ° F)										
MAX. CASE TEMP	90 °C (194 ° F) SEE FOOT NOTE WARRANTY										
ENERGY STAR 4.0	-----										
APPROVALS/CLASS	UL /cUL LISTED, CLASS " P ", 1 OUTDOOR										
REMOTE MOUNTING	18 FT MAX.										

MECHANICAL DATA

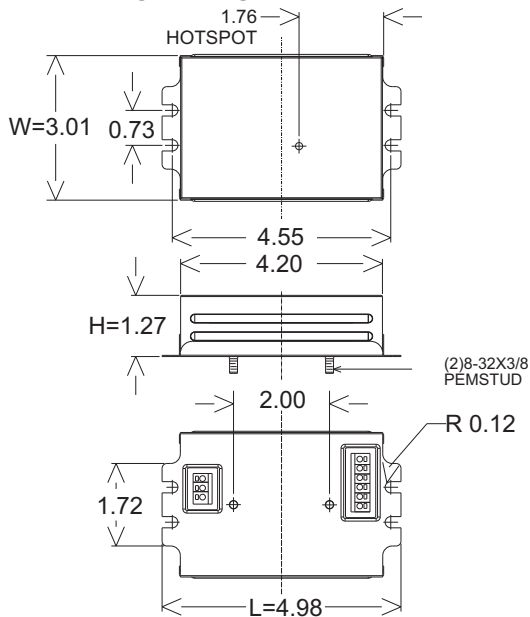

Where : L = Length, W = Width, H = Height

WIRING DIAGRAMS

1 X CFM57/70W, CFTE24-27/36/40W, 36TUV, CFTRE42W, 2D28/38W, T5CR40, GPH793T5L

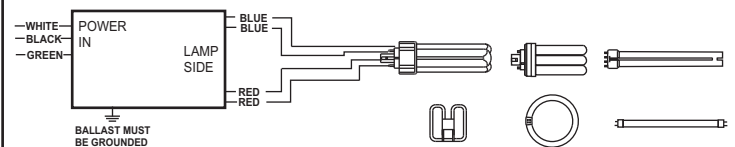

2 X CFTE24-27/36/40W, 36TUV, CFQE26W, CFTRE26/32/42W, 2D28/38W, T5CR22/40W, GPH793T5L

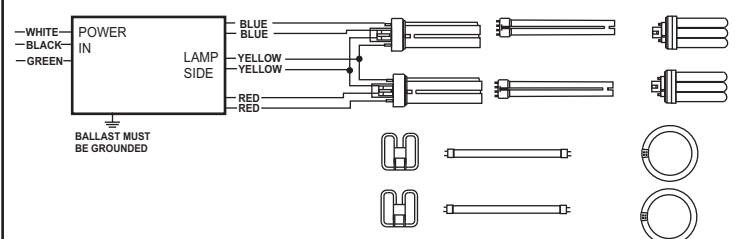

NOTE : This Ballast Must Be Grounded

Fulham extends a limited warranty only to the original purchaser or to the first user for a period of 3 years @ 90°C & 5 years @ 75°C from the date of manufacture when properly installed and operated under normal conditions of use. For complete terms and conditions, please reference the Fulham product catalog (www.fulham.com) Due to a program of continuous improvement, Fulham reserves the right to make modifications or variations in design or construction to the equipment described.

SPECIFICATION SHEET : RH4-UNV-242-BLS

This Is An Original Product From Fulham Co., Inc

Description : RACEHORSE Series, Universal Operating Voltage, Program Preheat Start Ballast, End Of Life Protection, Auto Restart, Cold Starting Feature.

This Ballast Will Operate Following Lamps.



TWIN(CFT/E), 4 PIN
24-27/36/40W/36TUV



QUAD (CFQ/E), 4 PIN
26W



TRIPLE(CFTR/E)
26W/32W/42W



2D28/38W



CFM57/70W



T5CR22/T5CR40

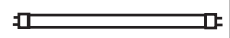

GPH793T5L

ELECTRICAL DATA (With 120 Volt Application-2 Lamps)

LAMP WATTS/TYPE	26CFQ/E	26CFTR/E	32CFTR/E	42CFTR/E	24/27CFT/E	36CFT/E	40CFT/E	2D28W	2D38W	T5CR22W	T5CR40W	36TUV	GPH793T5L
LAMPS OPERATED	2												
INPUT WATTS	56.07W	57.04W	66.85W	83.39W	50.63W	65.74W	89.45W	61.23W	62.34W	52.54W	78.24W	63.27W	65.74W
LINE CURRENT:	0.469A	0.477A	0.559A	0.697A	0.423A	0.550A	0.748A	0.511A	0.521A	0.439A	0.654A	0.529A	0.549A
POWER FACTOR	0.996	0.996	0.997	0.996	0.997	0.996	0.994	0.997	0.996	0.997	0.996	0.997	0.997
BALLAST FACTOR	1.044	1.035	0.963	0.893	1.027	0.939	1.019	1.198	0.829	1.088	0.916	0.758	0.820
EFFICACY FACTOR	1.862	1.815	1.441	1.071	2.028	1.428	1.139	1.956	1.329	2.070	1.171	1.199	1.247
THD %	2.6%	2.0%	2.7%	4.4%	2.3%	3.0%	4.7%	2.0%	2.7%	2.0%	3.5%	2.8%	8.7%
CURRENT CREST FACTOR	1.5	1.5	1.5	1.55	1.4	1.5	1.4	1.4	1.5	1.6	1.4	1.4	1.4
EMI/RFI COMPLIANCE	FCC PART 18-B (Consumer)												
SOUND RATING	" A "												
BALLAST TYPE	PROGRAMMED START												
VOLTAGE TRANSIENTS	MOV (ANSI C82.11)												
INPUT/PROTECTION	FUSE												
OUTPUT/PROTECTION	OPEN LAMP, SHORTED LAMP, END-OF-LIFE												
MIN. OPERATING TEMP	-30 °C (-22 °F)												
MAX. CASE TEMP	90 °C (194 °F) SEE FOOT NOTE WARRANTY												
ENERGY STAR 4.0	-----												
APPROVALS/CLASS	UL /cUL LISTED, CLASS " P ", 1 OUTDOOR												
REMOTE MOUNTING	18 FT MAX.												

MECHANICAL DATA

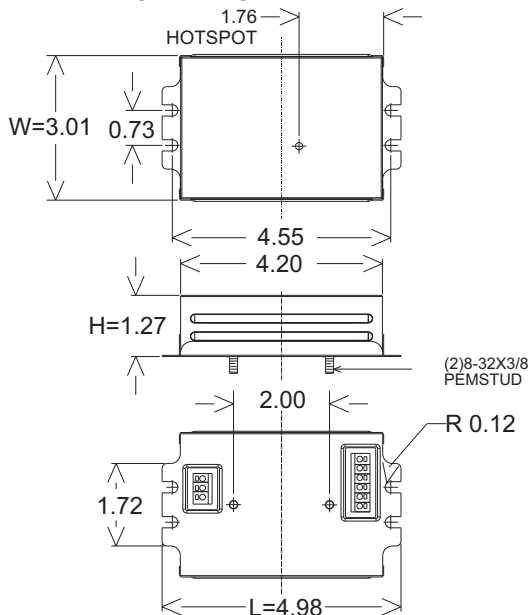

Where : L = Length, W = Width, H = Height

WIRING DIAGRAMS

1 X CFM57/70W, CFTE24-27/36/40W, 36TUV, CFTRE42W, 2D28/38W, T5CR40, GPH793T5L

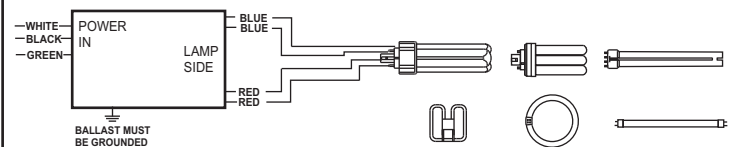

2 X CFTE24-27/36/40W, 36TUV, CFQE26W, CFTRE26/32/42W, 2D28/38W, T5CR22/40W, GPH793T5L

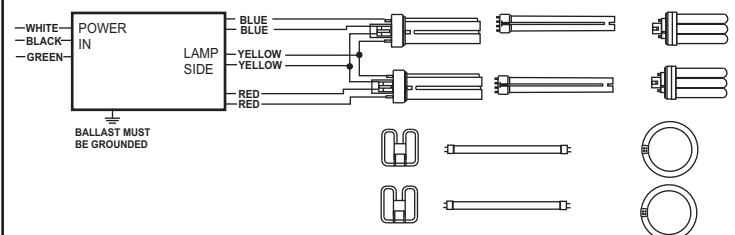

NOTE : This Ballast Must Be Grounded

Fulham extends a limited warranty only to the original purchaser or to the first user for a period of 3 years @ 90°C & 5 years @ 75°C from the date of manufacture when properly installed and operated under normal conditions of use. For complete terms and conditions, please reference the Fulham product catalog (www.fulham.com) Due to a program of continuous improvement, Fulham reserves the right to make modifications or variations in design or construction to the equipment described.

SPECIFICATION SHEET : RH4-UNV-242-BLS

This Is An Original Product From Fulham Co., Inc

Description : RACEHORSE Series, Universal Operating Voltage, Program Preheat Start Ballast, End Of Life Protection, Auto Restart, Cold Starting Feature.

This Ballast Will Operate Following Lamps.

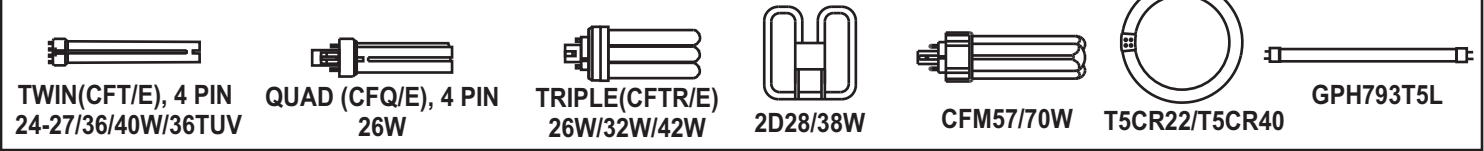

ELECTRICAL DATA (With 230 Volt Application-1 LAMP)

INPUT VOLT: 230V ± 10%, 50/60Hz											
LAMP WATTS/TYPE	CFM57	CFM70	42CFTR/E	24/27CFT/E	36CFT/E	40CFT/E	2D28W	2D38W	T5CR40	36TUV	GPH793T5L
LAMPS OPERATED	1										
INPUT WATTS	51.57W	73.64W	43.35W	28.18W	34.80W	45.89W	31.91W	34.40W	38.82W	34.06W	35.07W
LINE CURRENT:	0.227A	0.323A	0.191A	0.127A	0.155A	0.202A	0.142A	0.153A	0.172A	0.152A	0.156A
POWER FACTOR	0.988	0.991	0.984	0.965	0.978	0.985	0.976	0.977	0.980	0.975	0.978
BALLAST FACTOR	0.833	0.977	0.909	1.101	0.956	1.050	1.159	0.912	0.867	0.843	0.791
EFFICACY FACTOR	1.615	1.327	2.097	3.906	2.747	2.289	3.633	2.652	2.233	2.475	2.254
THD %	9.6%	7.0%	10.8%	14.6%	12.8%	10.7%	13.5%	12.9%	12.1%	12.8%	12.8%
CURRENT CREST FACTOR	1.5	1.5	1.6	1.5	1.5	1.5	1.5	1.6	1.6	1.6	1.5
EMI/RFI COMPLIANCE	FCC PART 18-B (Consumer)										
SOUND RATING	" A "										
BALLAST TYPE	PROGRAMMED START										
VOLTAGE TRANSIENTS	MOV (ANSI C82.11)										
INPUT/PROTECTION	FUSE										
OUTPUT/PROTECTION	OPEN LAMP, SHORTED LAMP, END-OF-LIFE										
MIN. OPERATING TEMP	-30 °C (-22 °F)										
MAX. CASE TEMP	90 °C (194 °F) SEE FOOT NOTE WARRANTY										
ENERGY STAR 4.0	-----										
APPROVALS/CLASS	UL /cUL LISTED, CLASS " P ", 1 OUTDOOR										
REMOTE MOUNTING	18 FT MAX.										

MECHANICAL DATA

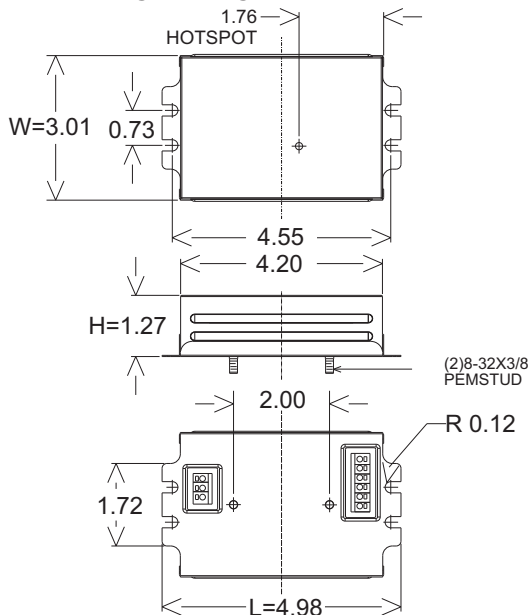

Where : L = Length, W = Width, H = Height

WIRING DIAGRAMS

1 X CFM57/70W, CFTE24-27/36/40W, 36TUV, CFTRE42W, 2D28/38W, T5CR40, GPH793T5L

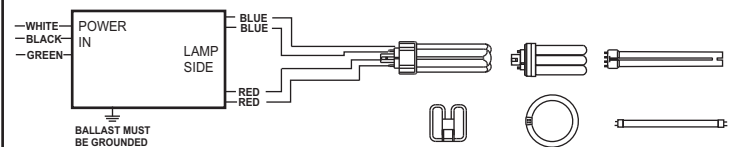

2 X CFTE24-27/36/40W, 36TUV, CFQE26W, CFTRE26/32/42W, 2D28/38W, T5CR22/40W, GPH793T5L

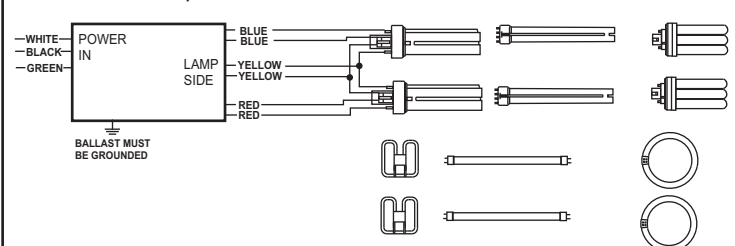

NOTE : This Ballast Must Be Grounded

Fulham extends a limited warranty only to the original purchaser or to the first user for a period of 3 years @ 90°C & 5 years @ 75°C from the date of manufacture when properly installed and operated under normal conditions of use. For complete terms and conditions, please reference the Fulham product catalog (www.fulham.com) Due to a program of continuous improvement, Fulham reserves the right to make modifications or variations in design or construction to the equipment described.

SPECIFICATION SHEET : RH4-UNV-242-BLS

This Is An Original Product From Fulham Co., Inc

Description : RACEHORSE Series, Universal Operating Voltage, Program Preheat Start Ballast, End Of Life Protection, Auto Restart, Cold Starting Feature.

This Ballast Will Operate Following Lamps.



TWIN(CFT/E), 4 PIN
24-27/36/40W/36TUV



QUAD (CFQ/E), 4 PIN
26W

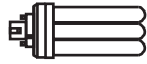

TRIPLE(CFTR/E)
26W/32W/42W



2D28/38W



CFM57/70W

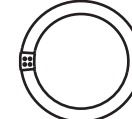

T5CR22/T5CR40

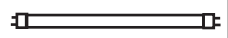

GPH793T5L

ELECTRICAL DATA (With 230 Volt Application-2 LAMP)

INPUT VOLT: 230V ± 10%, 50/60Hz													
LAMP WATTS/TYPE	26CFQ/E	26CFTR/E	32CFTR/E	42CFTR/E	24/27CFT/E	36CFT/E	40CFT/E	2D28W	2D38W	T5CR22W	T5CR40W	36TUV	GPH793T5L
LAMPS OPERATED	2												
INPUT WATTS	58.54W	54.52W	62.22W	83.93W	52.56W	65.64W	87.20W	59.97W	61.99W	50.85W	72.14W	63.88W	63.39W
LINE CURRENT:	0.257A	0.240A	0.273A	0.367A	0.231A	0.288A	0.381A	0.263A	0.272A	0.224A	0.316A	0.280A	0.278A
POWER FACTOR	0.989	0.989	0.992	0.995	0.988	0.993	0.996	0.990	0.992	0.989	0.994	0.991	0.991
BALLAST FACTOR	1.138	1.061	0.883	0.870	1.077	0.929	0.998	1.135	0.876	1.041	0.827	0.763	0.812
EFFICACY FACTOR	1.944	1.946	1.419	1.037	2.049	1.415	1.144	1.892	1.414	2.048	1.146	1.195	1.280
THD %	8.6%	9.1%	8.2%	5.8%	9.4%	7.8%	5.8%	8.3%	8.2%	9.6%	7.3%	7.8%	8.0%
CURRENT CREST FACTOR	1.5	1.5	1.5	1.5	1.5	1.4	1.43	1.5	1.5	1.5	1.5	1.5	1.5
EMI/RFI COMPLIANCE	FCC PART 18-B (Consumer)												
SOUND RATING	" A "												
BALLAST TYPE	PROGRAMMED START												
VOLTAGE TRANSIENTS	MOV (ANSI C82.11)												
INPUT/PROTECTION	FUSE												
OUTPUT/PROTECTION	OPEN LAMP, SHORTED LAMP, END-OF-LIFE												
MIN. OPERATING TEMP	-30 °C (-22 °F)												
MAX. CASE TEMP	90 °C (194 °F) SEE FOOT NOTE WARRANTY												
ENERGY STAR 4.0	-----												
APPROVALS/CLASS	UL /cUL LISTED, CLASS " P ", 1 OUTDOOR												
REMOTE MOUNTING	18 FT MAX.												

MECHANICAL DATA

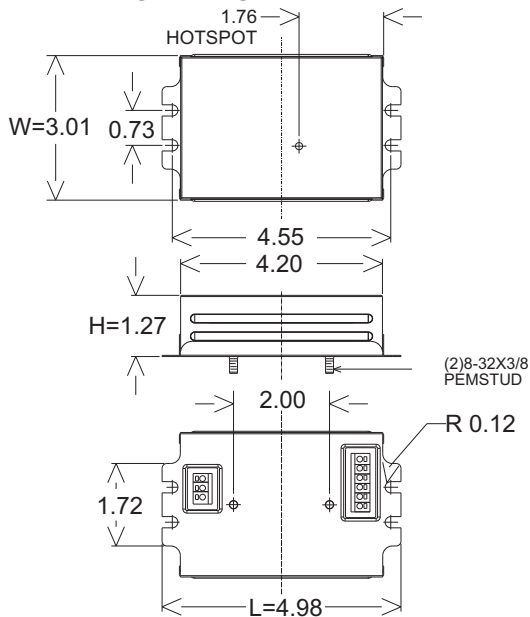

Where : L = Length, W = Width, H = Height

WIRING DIAGRAMS

1 X CFM57/70W, CFTE24-27/36/40W, 36TUV, CFTRE42W, 2D28/38W, T5CR40, GPH793T5L

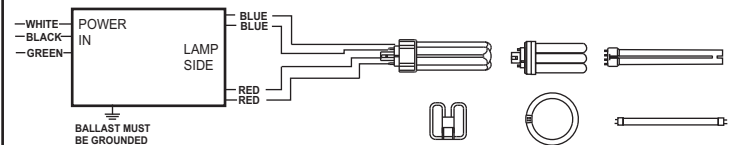

2 X CFTE24-27/36/40W, 36TUV, CFQE26W, CFTRE26/32/42W, 2D28/38W, T5CR22/40W, GPH793T5L

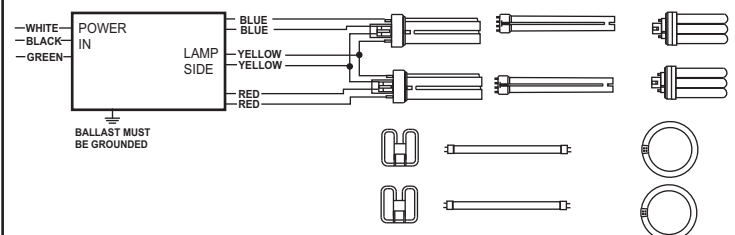

NOTE : This Ballast Must Be Grounded

Fulham extends a limited warranty only to the original purchaser or to the first user for a period of 3 years @ 90°C & 5 years @ 75°C from the date of manufacture when properly installed and operated under normal conditions of use. For complete terms and conditions, please reference the Fulham product catalog (www.fulham.com) Due to a program of continuous improvement, Fulham reserves the right to make modifications or variations in design or construction to the equipment described.

SPECIFICATION SHEET : RH4-UNV-242-BLS

This Is An Original Product From Fulham Co., Inc

Description : RACEHORSE Series, Universal Operating Voltage, Program Preheat Start Ballast, End Of Life Protection, Auto Restart, Cold Starting Feature.

This Ballast Will Operate Following Lamps.

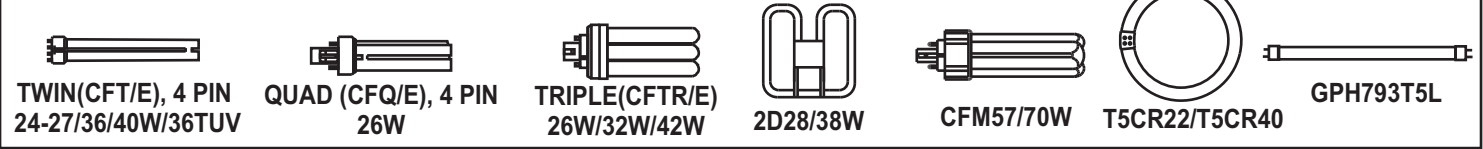

ELECTRICAL DATA (With 277 Volt Application-1 Lamp)

INPUT VOLT: 277V ± 10%, 50/60Hz											
LAMP WATTS/TYPE	CFM57	CFM70	42CFTR/E	24/27CFT/E	36CFT/E	40CFT/E	2D28W	2D38W	T5CR40	36TUV	GPH793T5L
LAMPS OPERATED	1										
INPUT WATTS	53.29W	73.46W	46.29W	27.29W	35.12W	46.72W	33.17W	32.05W	40.70W	34.02W	34.58W
LINE CURRENT:	0.196A	0.269A	0.171A	0.106A	0.132A	0.173A	0.126A	0.122A	0.152A	0.127A	0.131A
POWER FACTOR	0.982	0.986	0.979	0.929	0.960	0.976	0.953	0.949	0.965	0.964	0.955
BALLAST FACTOR	0.866	0.975	0.960	1.061	0.970	1.061	1.214	0.849	0.915	0.836	0.806
EFFICACY FACTOR	1.625	1.327	2.073	3.888	2.761	2.272	3.660	2.649	2.248	2.456	2.329
THD %	10.3%	7.6%	11.4%	21.3%	13.8%	11.5%	14.2%	14.3%	12.6%	14.0%	13.9%
CURRENT CREST FACTOR	1.5	1.5	1.5	1.6	1.5	1.5	1.5	1.6	1.6	1.6	1.6
EMI/RFI COMPLIANCE	FCC PART 18-B (Consumer)										
SOUND RATING	" A "										
BALLAST TYPE	PROGRAMMED START										
VOLTAGE TRANSIENTS	MOV (ANSI C82.11)										
INPUT/PROTECTION	FUSE										
OUTPUT/PROTECTION	OPEN LAMP, SHORTED LAMP, END-OF-LIFE										
MIN. OPERATING TEMP	-30 °C (-22 ° F)										
MAX. CASE TEMP	90 °C (194 ° F) SEE FOOT NOTE WARRANTY										
ENERGY STAR 4.0	-----										
APPROVALS/CLASS	UL /cUL LISTED, CLASS " P ", 1 OUTDOOR										
REMOTE MOUNTING	18 FT MAX.										

MECHANICAL DATA

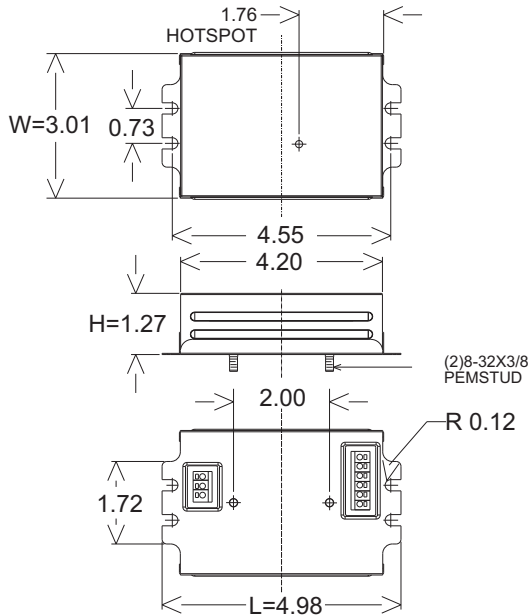

Where : L = Length, W = Width, H = Height

WIRING DIAGRAMS

1 X CFM57/70W, CFTE24-27/36/40W, 36TUV, CFTRE42W, 2D28/38W, T5CR40, GPH793T5L

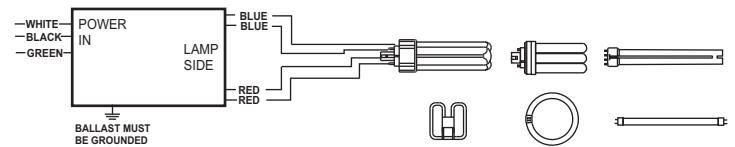

2 X CFTE24-27/36/40W, 36TUV, CFQE26W, CFTRE26/32/42W, 2D28/38W, T5CR22/40W, GPH793T5L

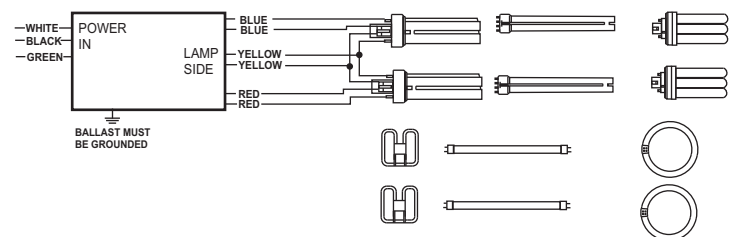

NOTE : This Ballast Must Be Grounded

Fulham extends a limited warranty only to the original purchaser or to the first user for a period of 3 years @ 90°C & 5 years @ 75°C from the date of manufacture when properly installed and operated under normal conditions of use. For complete terms and conditions, please reference the Fulham product catalog (www.fulham.com) Due to a program of continuous improvement, Fulham reserves the right to make modifications or variations in design or construction to the equipment described.

SPECIFICATION SHEET : RH4-UNV-242-BLS

This Is An Original Product From Fulham Co., Inc

Description : RACEHORSE Series, Universal Operating Voltage, Program Preheat Start Ballast, End Of Life Protection, Auto Restart, Cold Starting Feature.

This Ballast Will Operate Following Lamps.

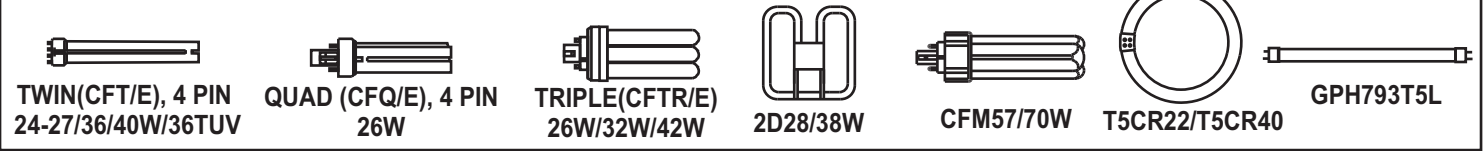

ELECTRICAL DATA (With 277 Volt Application-2 Lamp)

LAMP WATTS/TYPE	26CFQ/E	26CFTR/E	32CFTR/E	42CFTR/E	24/27CFT/E	36CFT/E	40CFT/E	2D28W	2D38W	T5CR22W	T5CR40W	36TUV	GPH793T5L
LAMPS OPERATED	2												
INPUT WATTS	55.20W	56.00W	59.88W	88.02W	50.83W	64.57W	88.14W	60.50W	63.08W	52.22W	76.48W	62.68W	64.60W
LINE CURRENT:	0.204A	0.206A	0.220A	0.321A	0.187A	0.237A	0.322A	0.222A	0.232A	0.193A	0.279A	0.230A	0.237A
POWER FACTOR	0.978	0.976	0.980	0.989	0.978	0.983	0.988	0.984	0.982	0.979	0.989	0.985	0.986
BALLAST FACTOR	1.033	1.025	0.878	0.975	1.039	0.934	1.029	1.182	0.830	1.093	0.904	0.762	0.820
EFFICACY FACTOR	1.871	1.830	1.465	1.108	2.044	1.423	1.167	1.954	1.315	2.093	1.182	1.215	1.269
THD %	10.1%	9.9%	9.2%	6.6%	10.6%	8.7%	6.3%	9.3%	8.8%	10.4%	7.3%	8.9%	8.7%
CURRENT CREST FACTOR	1.5	1.5	1.5	1.4	1.4	1.5	1.5	1.4	1.5	1.5	1.4	1.4	1.4
EMI/RFI COMPLIANCE	FCC PART 18-B (Consumer)												
SOUND RATING	" A "												
BALLAST TYPE	PROGRAMMED START												
VOLTAGE TRANSIENTS	MOV (ANSI C82.11)												
INPUT/PROTECTION	FUSE												
OUTPUT/PROTECTION	OPEN LAMP, SHORTED LAMP, END-OF-LIFE												
MIN. OPERATING TEMP	-30 °C (-22 °F)												
MAX. CASE TEMP	90 °C (194 °F) SEE FOOT NOTE WARRANTY												
ENERGY STAR 4.0	-----												
APPROVALS/CLASS	UL /cUL LISTED, CLASS " P ", 1 OUTDOOR												
REMOTE MOUNTING	18 FT MAX.												

MECHANICAL DATA

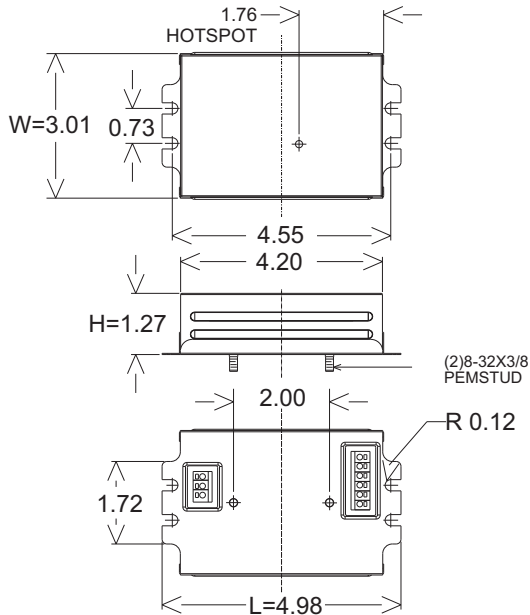

Where : L = Length, W = Width, H = Height

WIRING DIAGRAMS

1 X CFM57/70W, CFTE24-27/36/40W, 36TUV, CFTRE42W, 2D28/38W, T5CR40, GPH793T5L

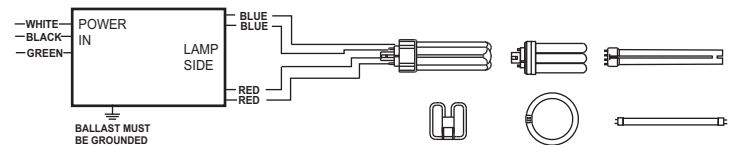

2 X CFTE24-27/36/40W, 36TUV, CFQE26W, CFTRE26/32/42W, 2D28/38W, T5CR22/40W, GPH793T5L

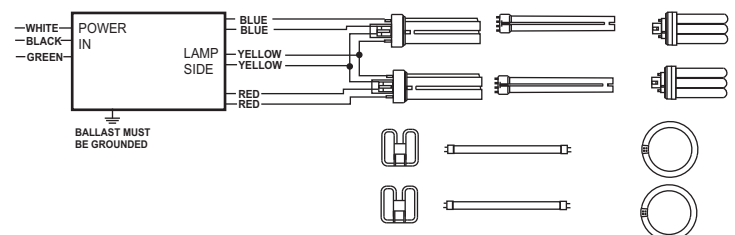

NOTE : This Ballast Must Be Grounded

Fulham extends a limited warranty only to the original purchaser or to the first user for a period of 3 years @ 90°C & 5 years @ 75°C from the date of manufacture when properly installed and operated under normal conditions of use. For complete terms and conditions, please reference the Fulham product catalog (www.fulham.com) Due to a program of continuous improvement, Fulham reserves the right to make modifications or variations in design or construction to the equipment described.