

### SPECIFICATION SHEET : RH3-UNV-226-C

This Is An Original Product From Fulham Co., Inc

**Description : RACEHORSE Series, Universal Operating Voltage, Programmed Start Ballast, End Of Life Protection, Auto Restart, Cold Starting Feature.**

**This Ballast Will Operate Following Lamps.**

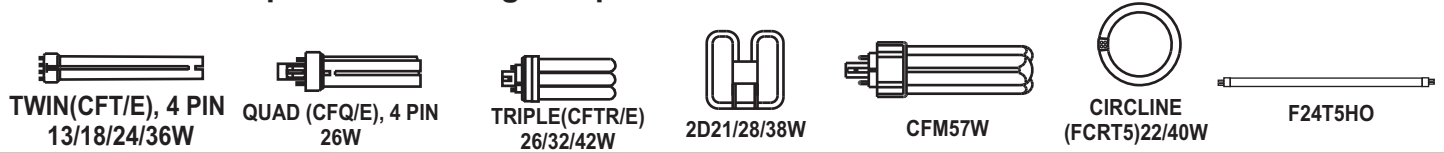

### ELECTRICAL DATA ( With 120 Volt Application )

INPUT VOLT: 120V ± 10%, 50/60Hz														
LAMP WATTS/TYPE	13CFT/E	26CFQ/E	26CFTR/E	32CFTR/E	42CFTR/E	2D21W	2D28W	2D38W	T5CR22	FT18W	FT36W	T5CR40	FT24/E	57CFM
LAMPS OPERATED	1													
INPUT WATTS	17	30	30	34	51	24	32	32	28	23	34	42	26	52
LINE CURRENT:	0.14	0.25	0.25	0.29	0.42	0.20	0.27	0.26	0.24	0.19	0.28	0.34	0.22	0.43
POWER FACTOR	0.99	0.99	0.99	0.99	0.99	0.99	0.99	0.99	0.99	0.99	0.99	0.99	0.99	0.99
BALLAST FACTOR	1.04	1.00	0.99	0.86	0.97	0.98	1.06	0.75	0.98	1.16	0.90	0.85	0.93	0.75
EFFICACY FACTOR	6.18	3.33	3.32	2.53	1.91	4.03	3.30	2.39	3.55	5.11	2.66	2.04	3.52	1.44
THD	< 10 %													
CURRENT CREST FACTOR	< 1.6													
EMI/RFI COMPLIANCE	FCC PART 18-B (Consumer)													
SOUND RATING	" A "													
BALLAST TYPE	PROGRAMMED START													
VOLTAGE TRANSIENTS	MOV (ANSI C82.11)													
INPUT/PROTECTION	FUSE													
OUTPUT/PROTECTION	OPEN LAMP, SHORTED LAMP, END-OF-LIFE													
MIN. OPERATING TEMP	-30 °C ( -22 ° F )													
MAX. CASE TEMP	90 °C ( 194 ° F ) SEE FOOT NOTE WARRANTY													
ENERGY STAR 4.0	-----													
APPROVALS/CLASS	UL /cUL LISTED, CLASS " P ", 1 OUTDOOR													
REMOTE MOUNTING	18 FT MAX.													

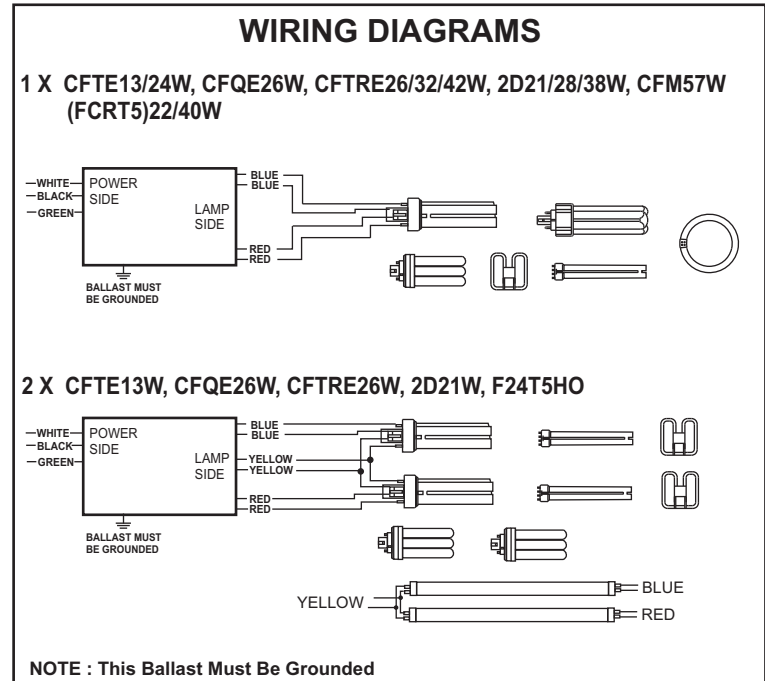
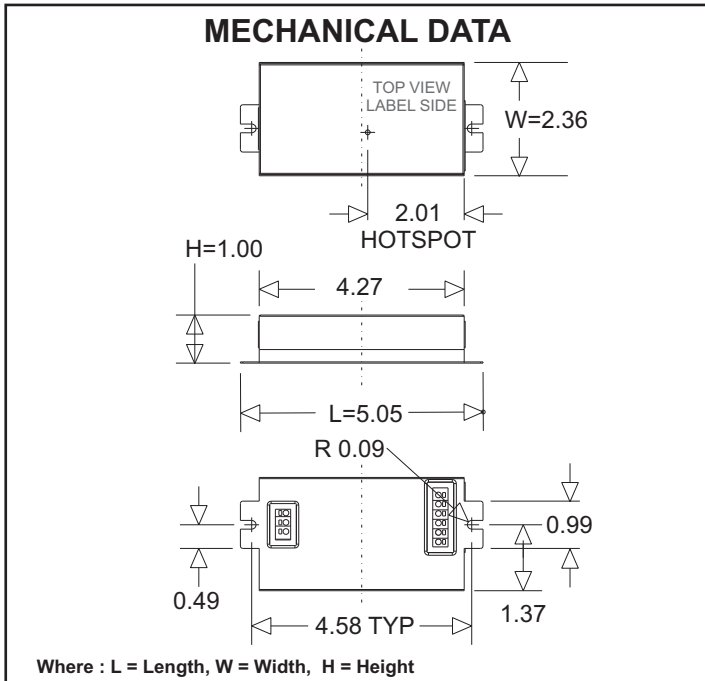

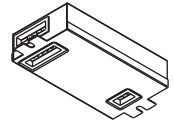

### SPECIFICATION SHEET : RH3-UNV-226-C

This Is An Original Product From Fulham Co., Inc

**Description : RACEHORSE Series, Universal Operating Voltage, Programmed Start Ballast, End Of Life Protection, Auto Restart, Cold Starting Feature.**

**This Ballast Will Operate Following Lamps.**



### ELECTRICAL DATA ( With 120 Volt Application )

INPUT VOLT: 120V ± 10%, 50/60Hz							
LAMP WATTS/TYPE	13CFT/E	FT18W	26CFQ/E	26CFTR/E	FT24/E	2D21W	F24T5HO
LAMPS OPERATED	2						
INPUT WATTS	31	42	58	58	49	46	50
LINE CURRENT:	0.26	0.36	0.48	0.48	0.41	0.38	0.42
POWER FACTOR	0.99	0.99	0.99	0.99	0.99	0.99	0.99
BALLAST FACTOR	1.02	1.14	0.97	0.97	0.89	1.03	0.94
EFFICACY FACTOR	3.30	2.67	1.68	1.68	1.80	2.26	1.88
THD	< 10 %						
CURRENT CREST FACTOR	< 1.6						
EMI/RFI COMPLIANCE	FCC PART 18-B (Consumer)						
SOUND RATING	" A "						
BALLAST TYPE	PROGRAMMED START						
VOLTAGE TRANSIENTS	MOV (ANSI C82.11)						
INPUT/PROTECTION	FUSE						
OUTPUT/PROTECTION	OPEN LAMP, SHORTED LAMP, END-OF-LIFE						
MIN. OPERATING TEMP	-30 °C ( -22 °F )						
MAX. CASE TEMP	90 °C ( 194 °F ) SEE FOOT NOTE WARRANTY						
ENERGY STAR 4.0	-----						
APPROVALS/CLASS	UL /cUL LISTED, CLASS " P ", 1 OUTDOOR						
REMOTE MOUNTING	18 FT MAX.						

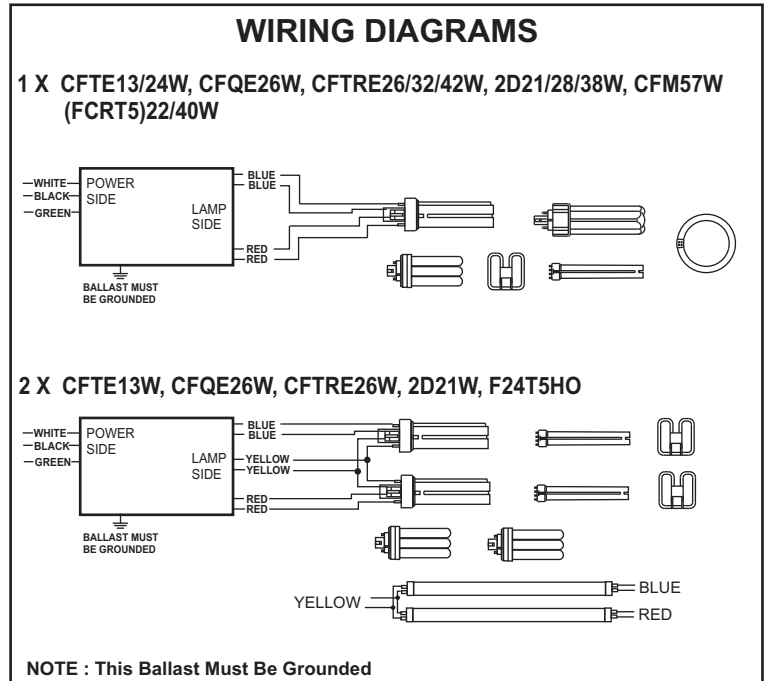
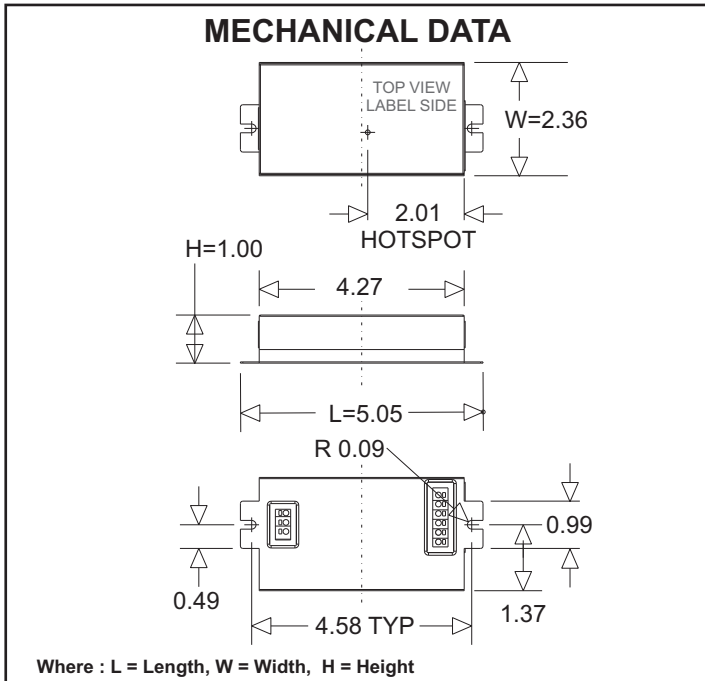

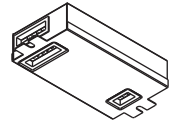

## SPECIFICATION SHEET : RH3-UNV-226-C

This Is An Original Product From Fulham Co., Inc

**Description : RACEHORSE Series, Universal Operating Voltage, Programmed Start Ballast, End Of Life Protection, Auto Restart, Cold Starting Feature.**

**This Ballast Will Operate Following Lamps.**

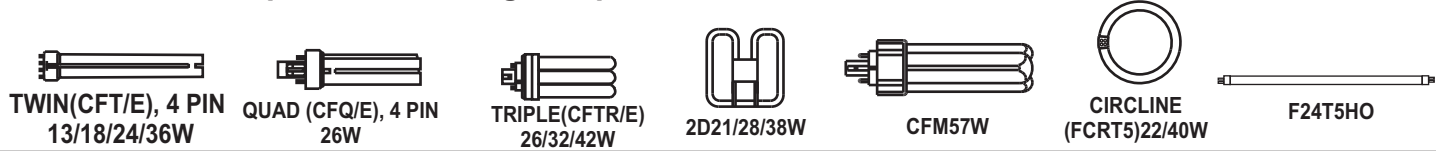

### ELECTRICAL DATA ( With 230 Volt Application )

INPUT VOLT: 230V ± 10%, 50/60Hz														
LAMP WATTS/TYPE	13CFT/E	26CFQ/E	26CFTR/E	32CFTR/E	42CFTR/E	2D21W	2D28W	2D38W	T5CR22	FT18W	FT36W	T5CR40	FT24/E	57CFM
LAMPS OPERATED	1													
INPUT WATTS	17	29	27	32	42	24	32	32	28	19	33	32	27	50
LINE CURRENT:	0.08	0.13	0.12	0.14	0.18	0.11	0.14	0.14	0.13	0.09	0.15	0.14	0.12	0.22
POWER FACTOR	0.96	0.98	0.98	0.98	0.99	0.97	0.98	0.99	0.98	0.96	0.98	0.98	0.98	0.99
BALLAST FACTOR	1.11	1.01	0.97	0.87	0.85	1.06	1.14	0.83	1.09	0.94	0.89	0.69	1.04	0.78
EFFICACY FACTOR	6.67	3.51	3.54	2.71	2.03	4.41	3.59	2.61	3.87	4.94	2.70	2.16	3.85	1.55
THD	< 14 %													
CURRENT CREST FACTOR	<													
EMI/RFI COMPLIANCE	FCC PART 18-B (Consumer)													
SOUND RATING	" A "													
BALLAST TYPE	PROGRAMMED START													
VOLTAGE TRANSIENTS	MOV (ANSI C82.11)													
INPUT/PROTECTION	FUSE													
OUTPUT/PROTECTION	OPEN LAMP, SHORTED LAMP, END-OF-LIFE													
MIN. OPERATING TEMP	-30 °C ( -22 ° F )													
MAX. CASE TEMP	90 °C ( 194 ° F ) SEE FOOT NOTE WARRANTY													
ENERGY STAR 4.0	-----													
APPROVALS/CLASS	UL /cUL LISTED, CLASS " P ", 1 OUTDOOR													
REMOTE MOUNTING	18 FT MAX.													

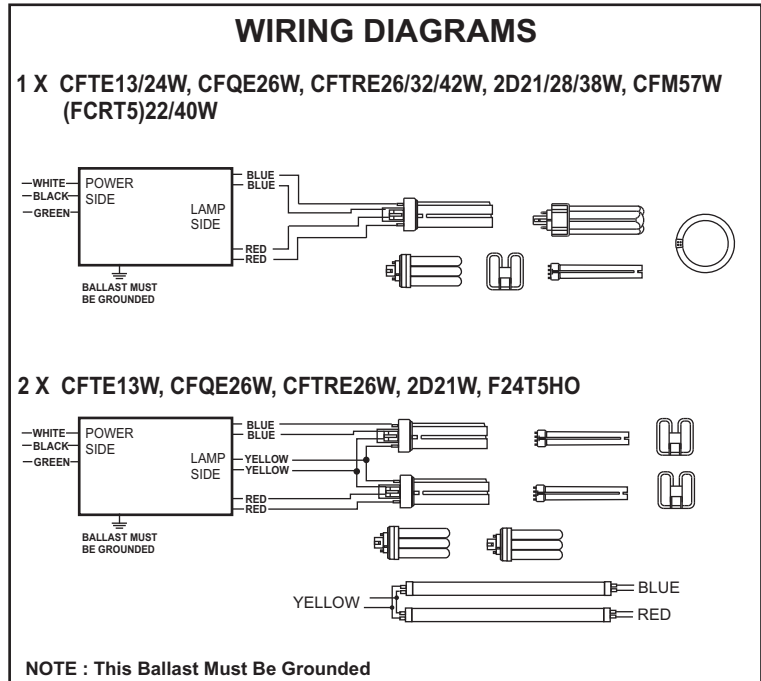
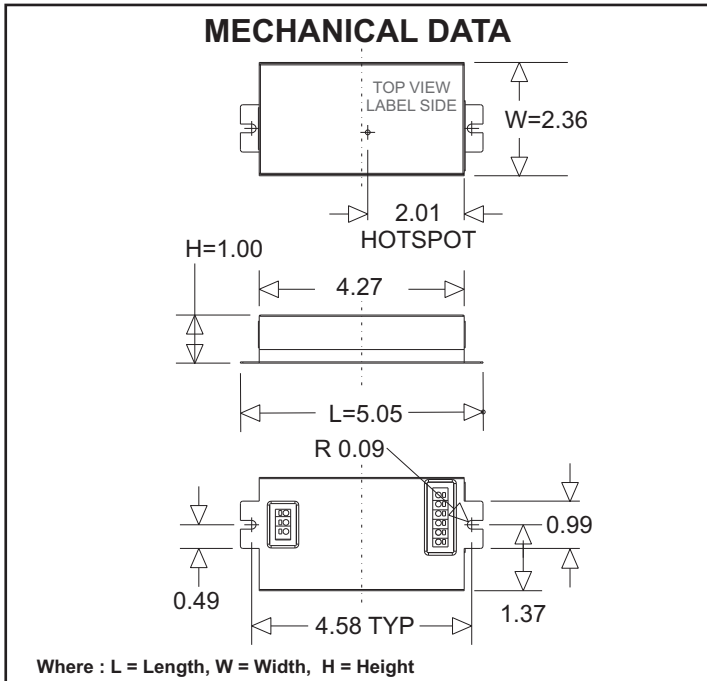

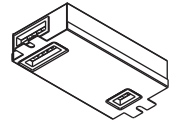

### SPECIFICATION SHEET : **RH3-UNV-226-C**

This Is An Original Product From Fulham Co., Inc

**Description : RACEHORSE Series, Universal Operating Voltage, Programmed Start Ballast, End Of Life Protection, Auto Restart, Cold Starting Feature.**

**This Ballast Will Operate Following Lamps.**

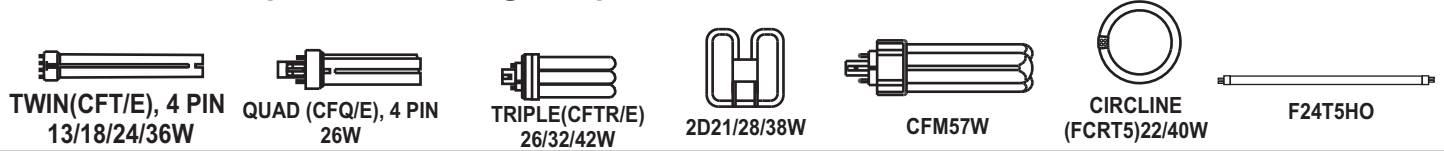

### ELECTRICAL DATA ( With 230 Volt Application )

INPUT VOLT : 230V ± 10%, 50/60Hz							
LAMP WATTS/TYPE	13CFT/E	FT18W	26CFQ/E	26CFTR/E	FT24/E	2D21W	F24T5HO
LAMPS OPERATED	2						
INPUT WATTS	29	34	53	54	48	46	50
LINE CURRENT:	0.13	0.15	0.23	0.24	0.21	0.20	0.22
POWER FACTOR	0.98	0.98	0.99	0.99	0.99	0.99	0.99
BALLAST FACTOR	1.09	0.91	0.96	0.95	0.97	1.02	0.96
EFFICACY FACTOR	3.71	2.67	1.81	1.77	2.03	2.25	1.93
THD	< 14 %						
CURRENT CREST FACTOR	<						
EMI/RFI COMPLIANCE	FCC PART 18-B (Consumer)						
SOUND RATING	" A "						
BALLAST TYPE	PROGRAMMED START						
VOLTAGE TRANSIENTS	MOV (ANSI C82.11)						
INPUT/PROTECTION	FUSE						
OUTPUT/PROTECTION	OPEN LAMP, SHORTED LAMP, END-OF-LIFE						
MIN. OPERATING TEMP	-30 °C ( -22 °F )						
MAX. CASE TEMP	90 °C ( 194 °F ) SEE FOOT NOTE WARRANTY						
ENERGY STAR 4.0	-----						
APPROVALS/CLASS	UL /cUL LISTED, CLASS " P ", 1 OUTDOOR						
REMOTE MOUNTING	18 FT MAX.						

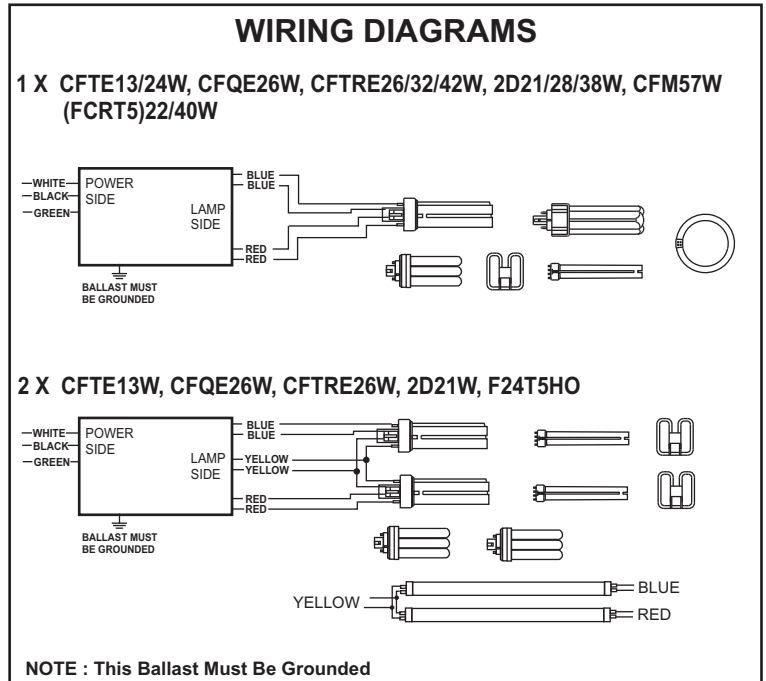
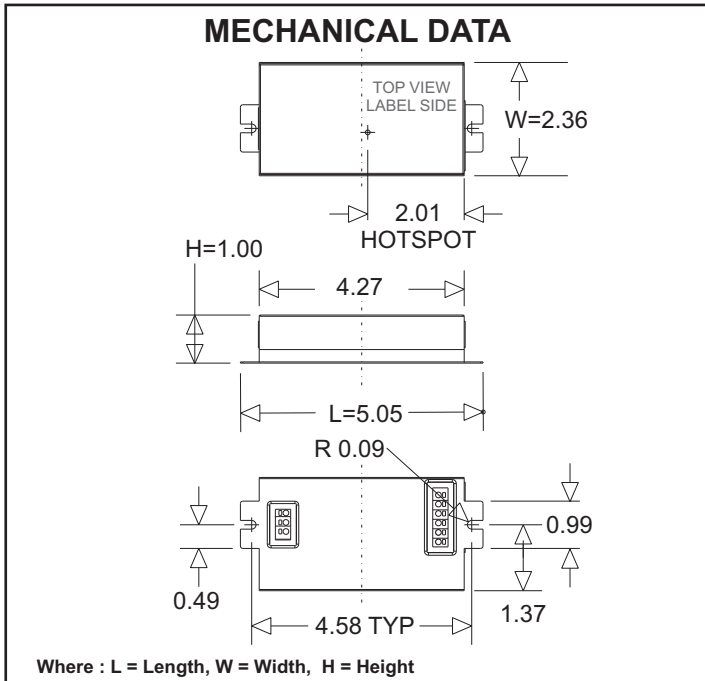

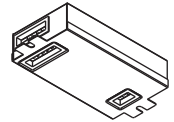

## SPECIFICATION SHEET : RH3-UNV-226-C

This Is An Original Product From Fulham Co., Inc

**Description : RACEHORSE Series, Universal Operating Voltage, Programmed Start Ballast, End Of Life Protection, Auto Restart, Cold Starting Feature.**

**This Ballast Will Operate Following Lamps.**



### ELECTRICAL DATA ( With 277 Volt Application )

INPUT VOLT: 277V ± 10%, 50/60Hz														
LAMP WATTS/TYPE	13CFT/E	26CFQ/E	26CFTR/E	32CFTR/E	42CFTR/E	2D21W	2D28W	2D38W	T5CR22	FT18W	FT36W	T5CR40	FT24/E	57CFM
LAMPS OPERATED	1													
INPUT WATTS	17	30	29	35	50	25	31	31	27	23	34	38	27	51
LINE CURRENT:	0.07	0.11	0.11	0.13	0.18	0.09	0.12	0.12	0.10	0.09	0.12	0.14	0.10	0.19
POWER FACTOR	0.93	0.97	0.97	0.98	0.99	0.96	0.98	0.97	0.97	0.95	0.97	0.98	0.97	0.99
BALLAST FACTOR	1.02	0.99	0.98	0.89	0.97	1.60	1.04	0.75	0.99	1.17	0.91	0.79	0.93	0.75
EFFICACY FACTOR	5.95	3.34	3.33	2.53	1.95	4.07	3.32	2.41	3.61	5.09	2.70	2.08	3.52	1.47
THD	< 10 %													
CURRENT CREST FACTOR	< 1.6													
EMI/RFI COMPLIANCE	FCC PART 18-B (Consumer)													
SOUND RATING	" A "													
BALLAST TYPE	PROGRAMMED START													
VOLTAGE TRANSIENTS	MOV (ANSI C82.11)													
INPUT/PROTECTION	FUSE													
OUTPUT/PROTECTION	OPEN LAMP, SHORTED LAMP, END-OF-LIFE													
MIN. OPERATING TEMP	-30 °C ( -22 °F )													
MAX. CASE TEMP	90 °C ( 194 °F ) SEE FOOT NOTE WARRANTY													
ENERGY STAR 4.0	-----													
APPROVALS/CLASS	UL /cUL LISTED, CLASS " P ", 1 OUTDOOR													
REMOTE MOUNTING	18 FT MAX.													

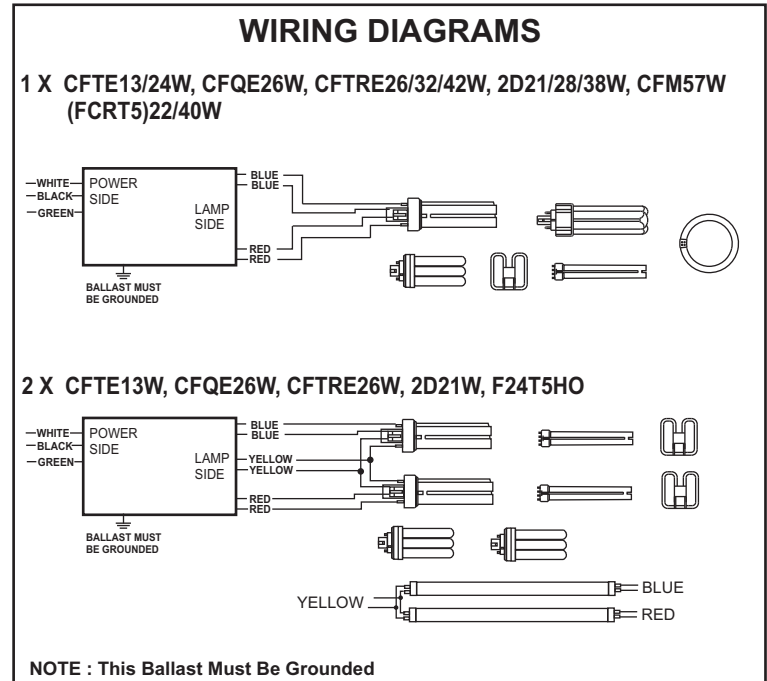
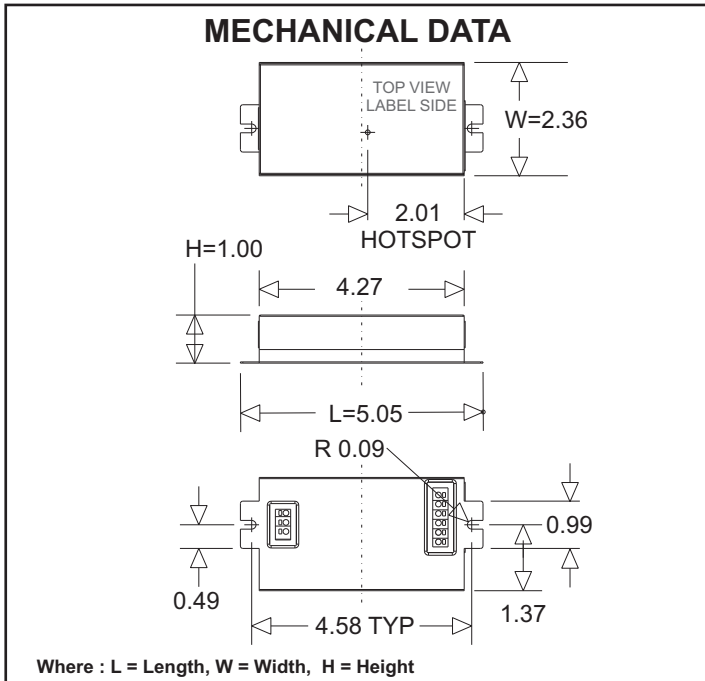

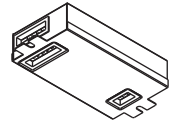

### SPECIFICATION SHEET : RH3-UNV-226-C

This Is An Original Product From Fulham Co., Inc

**Description : RACEHORSE Series, Universal Operating Voltage, Programmed Start Ballast, End Of Life Protection, Auto Restart, Cold Starting Feature.**

**This Ballast Will Operate Following Lamps.**



### ELECTRICAL DATA ( With 277 Volt Application )

INPUT VOLT: 277V ± 10%, 50/60Hz							
LAMP WATTS/TYPE	13CFT/E	FT18W	26CFQ/E	26CFTR/E	FT24/E	2D21W	F24T5HO
LAMPS OPERATED	2						
INPUT WATTS	26	42	56	56	48	44	49
LINE CURRENT:	0.11	0.02	0.21	0.20	0.18	0.16	0.18
POWER FACTOR	0.97	0.98	0.99	0.99	0.99	0.98	0.99
BALLAST FACTOR	0.99	1.14	0.97	0.97	0.90	0.98	0.94
EFFICACY FACTOR	3.82	2.73	1.73	1.74	1.86	2.23	1.91
THD	< 10 %						
CURRENT CREST FACTOR	< 1.6						
EMI/RFI COMPLIANCE	FCC PART 18-B (Consumer)						
SOUND RATING	" A "						
BALLAST TYPE	PROGRAMMED START						
VOLTAGE TRANSIENTS	MOV (ANSI C82.11)						
INPUT/PROTECTION	FUSE						
OUTPUT/PROTECTION	OPEN LAMP, SHORTED LAMP, END-OF-LIFE						
MIN. OPERATING TEMP	-30 °C ( -22 ° F )						
MAX. CASE TEMP	90 °C ( 194 ° F ) SEE FOOT NOTE WARRANTY						
ENERGY STAR 4.0	-----						
APPROVALS/CLASS	UL /cUL LISTED, CLASS " P ", 1 OUTDOOR						
REMOTE MOUNTING	18 FT MAX.						

