



IHCV-1M1UNV024V-60L

Constant Voltage LED Driver

- Input Voltage:110-277V~, 50/60Hz
- Output Current:2.5A Max.
- Output Voltage:24V== +/-5%
- Output Power:60W Max.
- IP65
- 0-10V Dimmable, 100%-1%, 0%

General Specifications

Input Voltage / Frequency	110-277V~, 50/60Hz, +/- 10%
Input Current	≤TBDA@110V at Full Load
Input Power	70W
Input PF	≥0.9@ Full Load
THD	<20%@ Full Load
Efficiency	86% Typical
Startup Inrush Current/Time	Cold Start: TBD A @277V
Max Leakage Current	≤0.7mA @277V
Output Voltage Range	24V==
Output Current	2.5A Max.
Output Overshoot/Undershoot Voltage	≤5% @Startup and Shutdown
Output Ripple Voltage	<10% @Full Load
Output Tolerance	+/- 5%
Dimming Type/Range	0-10V / 100% - 1%, 0%
Dimming Isolation	Yes
Operating Ambient Temperature Range	-40°C to 55°C (-40°F to 131°F)
Maximum Driver Case Temperature (Tc) (Per UL)	90°C (194°F)
Start-up Time	0.5s
Standby Power	TBD
Driver Output Type / Number of Output Channels	Constant Voltage - Class 2 / 1 Channel
Overall Size	9.52" L x 1.75" W x 1.20" H (241.8mm L x 44.5mm W x 30.5mm H)
Wire Type / Length	18AWG / TBD"
Weight	TBD g / TBD lbs.
Safety / Compliance	UL8750, UL1310, CAN/CSA-C22.2 NO. 250.13 Class P Listed RoHS Compliant Class 2 Suitable for Dry and Damp locations
IP Rating	IP65
Withstand Voltage	I/P-O/P:3750VAC, I/P-FG:1875VAC O/P-FG:500VAC
Insulation Resistance	I/P-O/P, I/P-FG, O/P-FG:100M Ohms/ 500VDC/25°C/70%RH
EMC Emission	FCC Title 47 Part 15B, Class B at 110VAC / Class A at 277VAC
Operating Humidity	5-95% RH Non-condensing
Protections	Input Surge Line-Neutral 2KV, Line & Neutral-Ground 2KV(Ringwave 2.5KV / 2.5KV) Over Power Protection, Over Current Protection, Over Voltage Protection Output Short Circuit Protection(Recovers automatically after short is removed) Over Temperature Protection
Hot Swappable	No
Sound Rating	A
Service Life	50,000 hours lifetime @ Tc 80°C (176°F)
Warranty	5 years @ Tc 80°C (176°F) from the date of manufacture

*FG = Fault Ground **I/P = Input Power ***O/P = Output Power

IHCV-1M1UNV024V-60L

Mechanical Data

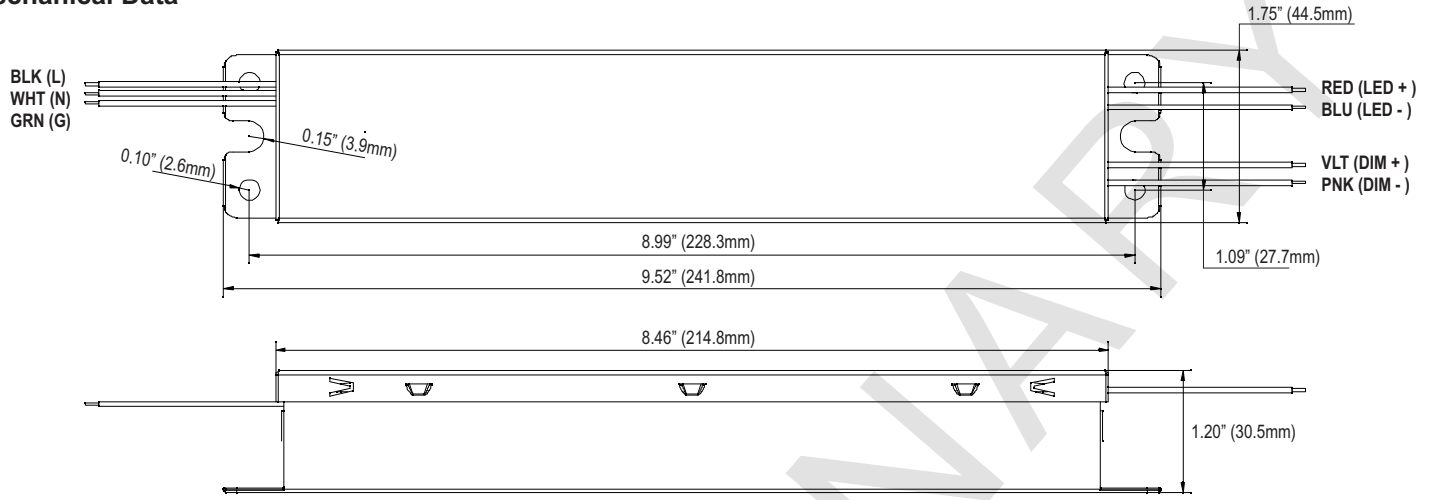

Overall Dimensions	
Length	9.52" [241.8mm]
Width	1.75" [44.5mm]
Height	1.20" [30.5mm]
Wire Length	
AC Input (White/Black/Green)	TBD" [TBDmm]
LED Output (Red/Blue)	TBD" [TBDmm]
Dimming (Violet/Pink)	TBD" [TBDmm]

Note: Wire Tolerance is +/- 0.78" (20mm)

Wiring Diagram

