

Project: _____ Type: _____ Model No.: _____

Remarks: _____

HotSpot UL Classified Kits



Installed Kit

Specification:



INPUT VOLTAGE	120V - 277V ± 10%, 47-63Hz
SURGE PROTECTION	C62.41 (TVS)
OVER CURRENT PROTECTION	FUSE
INPUT CURRENT	0.07A
INPUT POWER	<4W
LUMEN OUTPUT	500 LUMENS
MAXIMUM OUTPUT CURRENT	2.1 AMP WHEN USED WITH # FHSBATT3-C3
OUTPUT VOLTAGE	3.6V
OUTPUT SHORT CIRCUIT PROTECTION	SELF RESETTING PTC
RECHARGE TIME REQUIRED	24 HRS
BATTERY TYPE	NiCd 3.6VDC
BATTERY CAPACITY AVAILABLE	3Ah
ILLUMINATION TIME	MINIMUM 90 MIN
ESTIMATED RUN TIME	145 MIN
OUTPUT CLASSIFICATION	UL 1310 / CLASS 2
AMBIENT TEMPERATURE	0°C - 50°C

Mechanical Data:

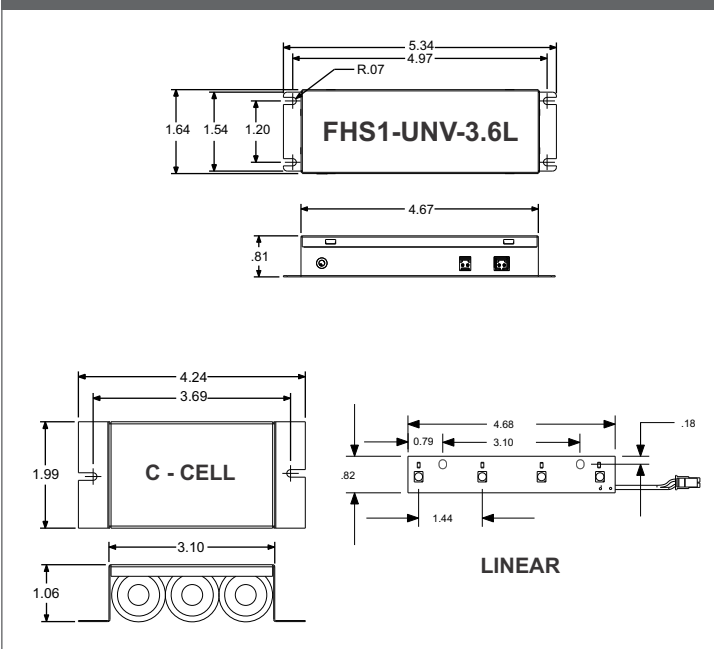

Wiring Diagram

WIRE	BLACK	WHITE	BATTERY- LED ARRAY- TEST SWITCH- PILOT LIGHT
LENGTH - INCHES	12 ± 1"	12 ± 1"	24 ± 1"

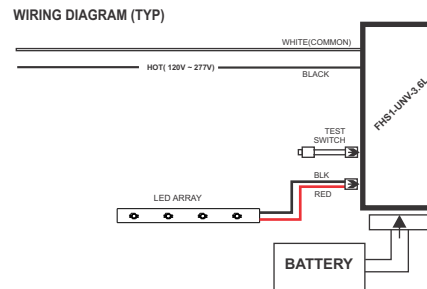
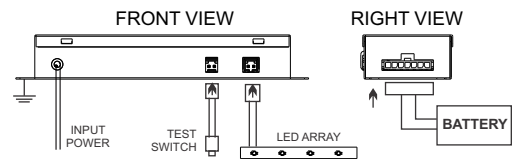

Fulham extends a limited warranty only to the original purchaser or to the first user for a period of 5 years from the date of manufacture when properly installed and operated under normal conditions of use. For complete terms and conditions, please reference the Fulham product catalog (www.fulham.com) Due to a program of continuous improvement, Fulham reserves the right to make modifications or variations in design or construction to the equipment described.