

Basic Collection

HIGHBAYS / LOWBAYS

Discontinued
Contact Fulham for availability. Not for use in new designs.



HB05 Induction Highbay Series



DISC INDUCTION GENERATOR

CIRCULAR INDUCTION
70W – 200W

MOUNTING HEIGHT
10' TO 30'

DIMMING WATTAGES
CIRCULAR 150W-200W



The **HB05 Induction Highbay Series** can be used in a variety of applications including manufacturing, gymnasiums, warehouse facilities, exhibition halls, industrial, and commercial environments. A more stylish low profile series and a slick design. Optimized for heights of 10ft to 30ft. High purity aluminum housing reflector for higher illumination at work plane. The Induction system operates well in cold temperatures with an instant ON/re-strike capability. The long life and superior lumen maintenance of Induction significantly reduces maintenance costs and provides a significant reduction in the total cost of ownership.

APPLICATION -

- Manufacturing
- Gymnasiums
- Warehouse
- Intended use for Replacements of HID High Bay

- Exhibition Hall
- Large Area Retail
- Industrial

CONSTRUCTION -

- Aluminum Housing, Vacuum Coated Inner Surface
- Disc Generator – Externally Mounted (IP43), Powder Coated White (Standard)

- Acrylic Lens (Available Without Lens Upon Request)
- Pendant Mount or Hook
- Aluminum Finish

ELECTRICAL -

- Universal Voltage (120V – 277V)
- High Power Factor (>.95)
- Ambient Temperature Rating: -20°C to 40°C
- Input Frequency: 50/60 Hz
- Operating Frequency: 250 kHz
- Step Down Transformer Voltage: 347V/480V to 277V
- CSA: 208V-347V
- CE: 208V-240V

- Pre-Wired Output Connector (Plug and Play)
- Constant Wattage Output With Less Than 3% Variance
- No Variation Over a Wide Range of Temperatures and Voltage Fluctuation
- Instant On
- No Noise Compare to HID Systems
- THD %: < 10%
- Generator Type: Class P Type 1 outdoor, IP43

LAMP TYPE/WATTAGES -

- Circular Induction Lamps Available: 70W¹, 80W¹, 100W¹, 120W¹, 150W, 200W
- Standard Kelvin Temperature is 5000K: Provides a Cooler Color Temperature
- Wide Range of Color Temperature Options 2700K – 6500K¹ Available

- Pre-Wired Input Connector
- Vibration and Shock Resistant: No Filament
- Low Lumen Depreciation, >70% Lumen Maintenance at 60,000 Hours
- CRI >80

COMPLIANCE -

- UL listed – UL 1598 (E363375)
- cUL listed – UL 1598 (E363375)
- CSA listed¹: 70W, 80W, 100W, 120W, 150W, 200W
- CE listed¹: 80W, 100W, 120W, 150W, 200W

- IP20: For use in Dry Locations only
- Surge Immunity – IEC 61000-4-5: Class 4
- FCC Part 18-A

DIMMING INDUCTION GENERATOR SPECIFICATIONS -

- Dimming interface is electrically isolated for safety and reliability
- Dimmable Induction generator can work as a regular generator to drive the lamp at full range when the 0-10V interface is not connected.
- The output wattage is about 50% at 0-3VDC.
- The output wattage is dimmed from 100% to 50% at the 9-3VDC.
- Dimming wires: Violet (+), Gray (-)
- The output wattage is 100% at 9-10VDC.

- The output wattage is at the 100% range when the system is power ON. If the system is set on a dim level then it will dim within 30 seconds.
- Shorting the two dimming wires (Violet and Gray) sets the system to the lowest dim level of 50%, acting as a bi-level dimming system.

OPTICS -

- Acrylic Lens
- High Reflectance Aluminum Housing

- Type V Distribution

WARRANTY -

- Five-year Limited Warranty

NOTE:
1 Consult with your sales representative for availability.
2 Consult with your sales representative for lead time
3. Dimming Generator, No Sensor included

Actual performance may differ as a result of end-user environment and application.
Note: Specifications subject to change without notice.

ORDERING OPTIONS

Lead times will vary depending on options selected. Consult with your sales representative.

TYPE	SERIES	LAMP	WATTAGE	LENS	REFRACTOR DIA	ORDERING OPTIONS
HB = HIGHBAY	05 = 05 SERIES	C = CIRCULAR	070 = 70W ¹	BLANK = NO LENS	19"	M = 0-10V Dimming ³ BLANK = 5000K 27 = 2700K 30 = 3000K 40 = 4000K 60 = 6000K 65 = 6500K J = CSA ¹ Z = CE ¹
			080 = 80W ¹			
100 = 100W ¹						
			120 = 120W ¹	A = ACRYLIC	22"	
			150 = 150W			
			200 = 200W			

Example: HB-05-C200-A-22 (Highbay 05 series Circular 200W lamp with 22" Acrylic lens)

Basic Collection

HIGHBAYS / LOWBAYS

Discontinued
Contact Fulham for availability. Not for use in new designs.



HB05 Induction Highbay Series

ACCESSORIES

DESCRIPTION:	PART NUMBER:
STEP DOWN TRANSFORMER	
35W - 100W	HH-ILS-SD1-125VA
120W - 200W	HH-ILS-SD2-245VA
250W - 400W	HH-ILS-SD3-460VA
STEP-DOWN TRANSFORMER HOUSING KIT	
Housing for all three transformer options	HHILPQ32840
HIGHBAY PERFORMANCE REFLECTOR	
150W/200W	HHILPF00020

ELECTRICAL CHARACTERISTICS

MODEL NO.	RATED WATTAGE (W)	INPUT POWER (W)	INPUT CURRENT 120V - 277V (AMP)	LAMP RATED INITIAL LUMINANCE (LM)	EFFICACY (LM/W)	LUMEN MAINTENANCE	COLOR RENDERING INDEX	CCT (KELVIN)
HB05-C070-A-19 HB05-C070-19	70	74	0.62 - 0.27	5250	70 - 75	70%-75%	> 80	5000
HB05-C080-A-19 HB05-C080-19	80	84	0.70 - 0.30	6000	70 - 75			
HB05-C100-A-19 HB05-C100-19	100	105	0.88 - 0.38	8000	75 - 80			
HB05-C120-A-22 HB05-C120-22	120	126	1.05 - 0.45	9600	75 - 80			
HB05-C150-A-22/M HB05-C150-22/M	150	158	1.32 - 0.57	12750	80 - 85			
HB05-C200-A-22/M HB05-C200-22/M	200	210	1.75 - 0.76	17000	80 - 85			

Mechanical Data

NOTE: PENDANT MOUNT IS FOR A 3/4" THREADED PIPE

HOOK OR PENDANT MOUNT

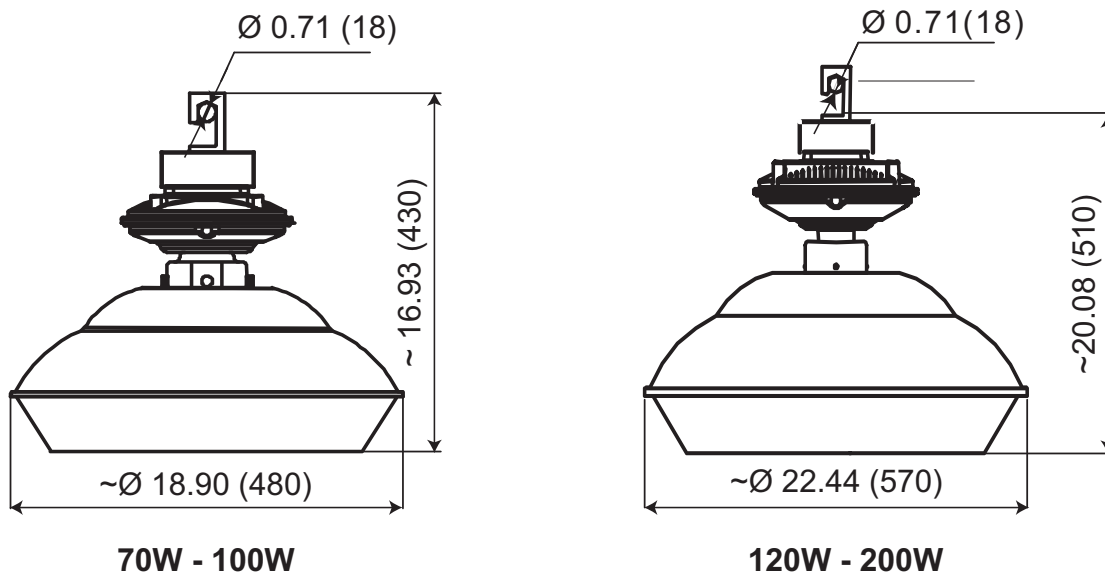

All dimensions are shown in inches (millimeters) unless otherwise noted.

Photometric Data

IES files available upon request.

POLAR GRAPH

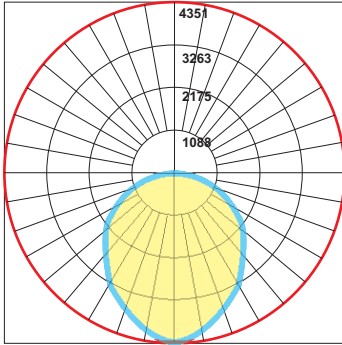

HB05-C200-A-22/M

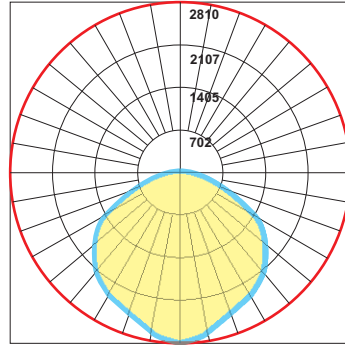

HB05-C150-A-2/M2

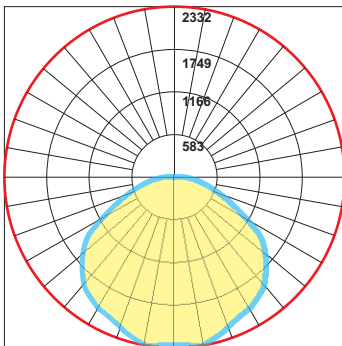

HB05-C120-A-22

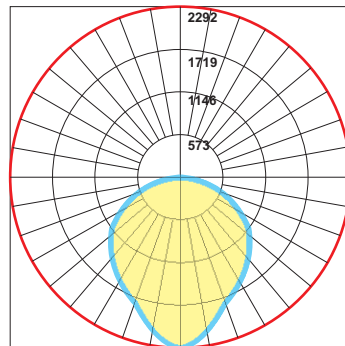

HB05-C100-A-19

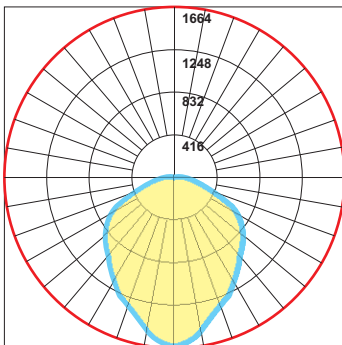

HB05-C80-A-22

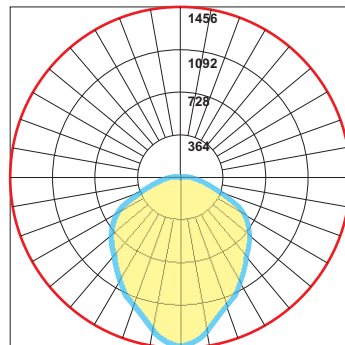

HB05-C70-A-22

ILLUMINANCE AT DISTANCE

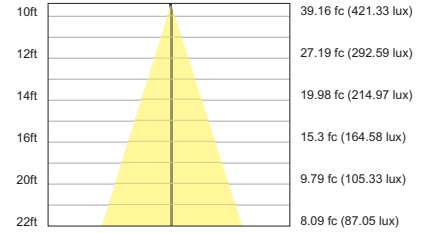

HB05-C200-A-22/M

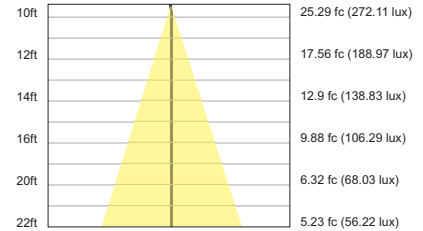

HB05-C150-A-22/M

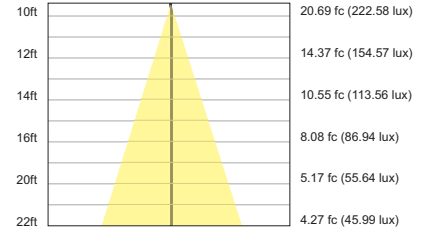

HB05-C120-A-22

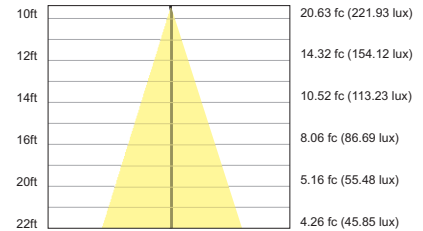

HB05-C100-A-19

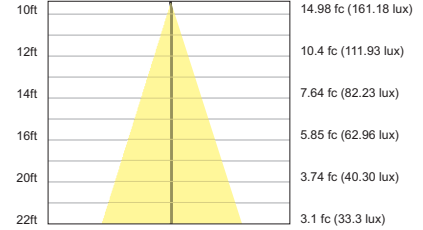

HB05-C80-A-22

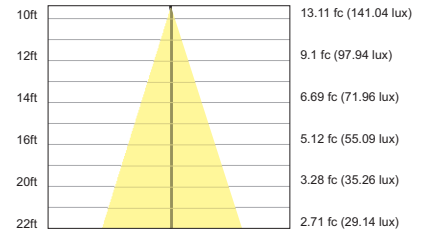

HB05-C70-A-19

Located At Horizontal Angle = 0, Vertical Angle = 0
 # 1 - Vertical Plane Through Horizontal Angles (0 - 180) (Through Max. Cd.)
 # 2 - Horizontal Cone Through Vertical Angle (0) (Through Max. Cd.)