



T1C1240012V-50FE

SPECIFICATIONS



- Leading & Trailing Edge Triac dimable
- Constant Voltage LED Driver
- Flicker free, O/P Ripple Current < 5% (LF)
- Dimming level 20% to 100%
- Output Wattage 50W
- Output Voltage: 12Vdc
- Output Current range: 1.60A - 4.16A
- SELV Equivalent
- Application
 - LED indoor lighting
 - LED architectural lighting

General Specifications

Rated Input Voltage	220-240/240/230VAC, 50/60Hz
Operating Input Voltage Range	230VAC (198-264Vac), 50/60Hz
Input Current	0.35 A Max.
Input Power	58W Max.
Power Factor	>0.95 @ 230Vac Full Load
THD	< 20% @ 230Vac Full Load
Efficiency	>85%
Driver Type	Constant Voltage
Output Current	4.16A
Output Voltage Range	12VDC
Output Power	50W
Inrush Current	75A
Stand by power	< 0.5W
O/P Ripple Current	< ±5% Ripple current, LF ≤120Hz
Number of Output Channels	1 Channel
Dimming Controller Type/Dimming Range	Triac, Leading Edge & Trailing Edge Dimming
RFI/EMI	CE
Output Type	Class II
Ambient Operating Temperature Range	-20°C to 45°C
Max. Case Temperature	85°C
Sound Rating	NA
Input Surge Protection	Line-Neutral 1kV
Protections	Input Over Current : NON-Resettable Output Short Circuit : hiccup mode, Auto recovery after short circuit removed Output Open Circuit : hiccup mode Output Overload : Auto recovery Over Temperature : NA
Standards	EN55015, EN61000-3-2, EN62493:2015 EN61347-2-13:2014+A1, EN61347-1:2015
Withstand Voltage	I/P-O/P:3750Vac
Leakage Current	<0.5mA @ 240Vac
Isolation resistance	I/P-O/P:10MΩ / 500Vdc / 25°C / 70% RH
Life	30,000 Hours @ 75°C
Approvals / Class	SELV Equivalent
Warranty	5 Years at Tc 75°C
Weight	0.250 Kg

Note : Suitable for indoor application only

Fulham extends a limited warranty only to the original purchaser or to the first user for a period of 5 years @ Tc 75°C from the date of manufacture when properly installed and operated under normal conditions of use. For complete terms and conditions, please reference the Fulham Product Catalog (www.fulham.com). Due to a program of continuous improvement, Fulham reserves the right to make modifications or variations in design or construction to the equipment described. © Fulham Company Limited, All Rights Reserved.

Typical Efficiency Vs Load %

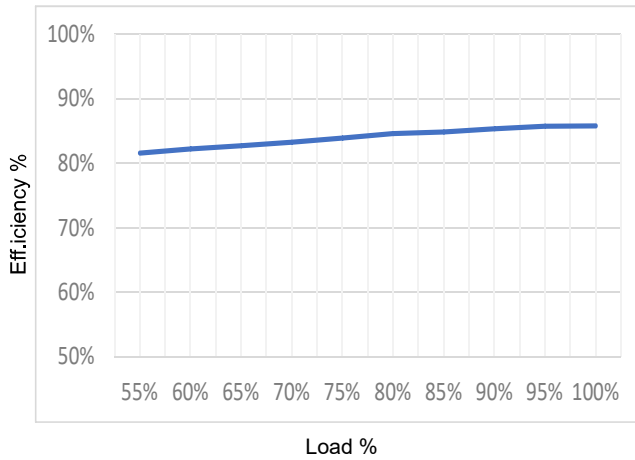

Power factor vs Load

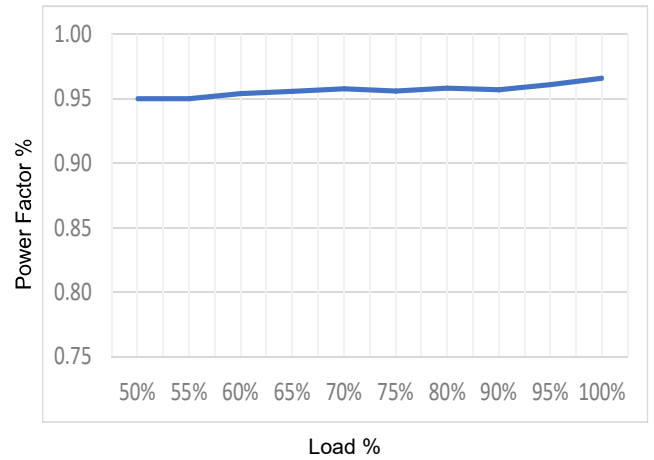

A-THD Vs Load %

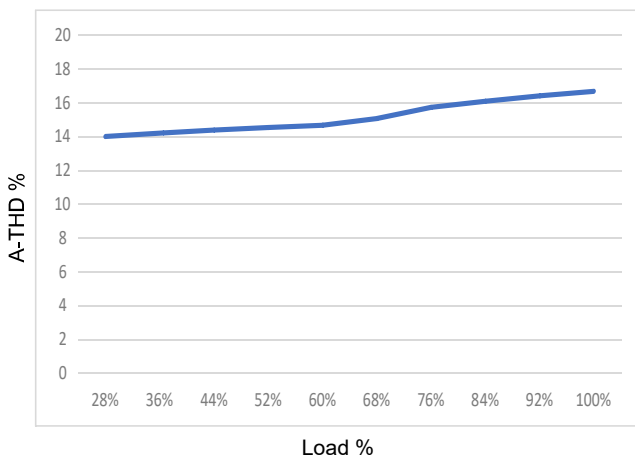

Life VS Tc

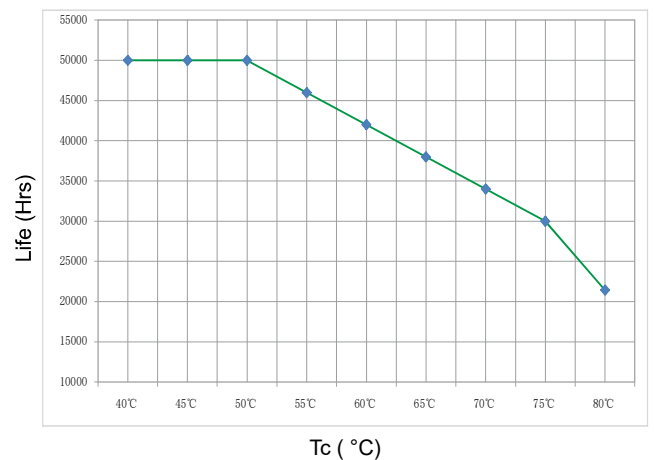

Wiring Diagrams

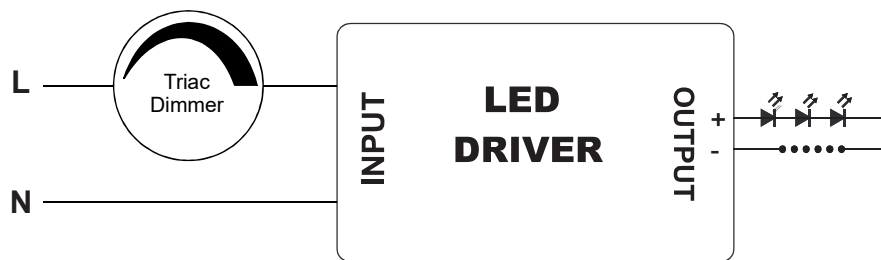

Fulham extends a limited warranty only to the original purchaser or to the first user for a period of 5 years @ Tc 75°C from the date of manufacture when properly installed and operated under normal conditions of use. For complete terms and conditions, please reference the Fulham Product Catalog (www.fulham.com). Due to a program of continuous improvement, Fulham reserves the right to make modifications or variations in design or construction to the equipment described. © Fulham Company Limited, All Rights Reserved.

Product Image



Mechanical Data

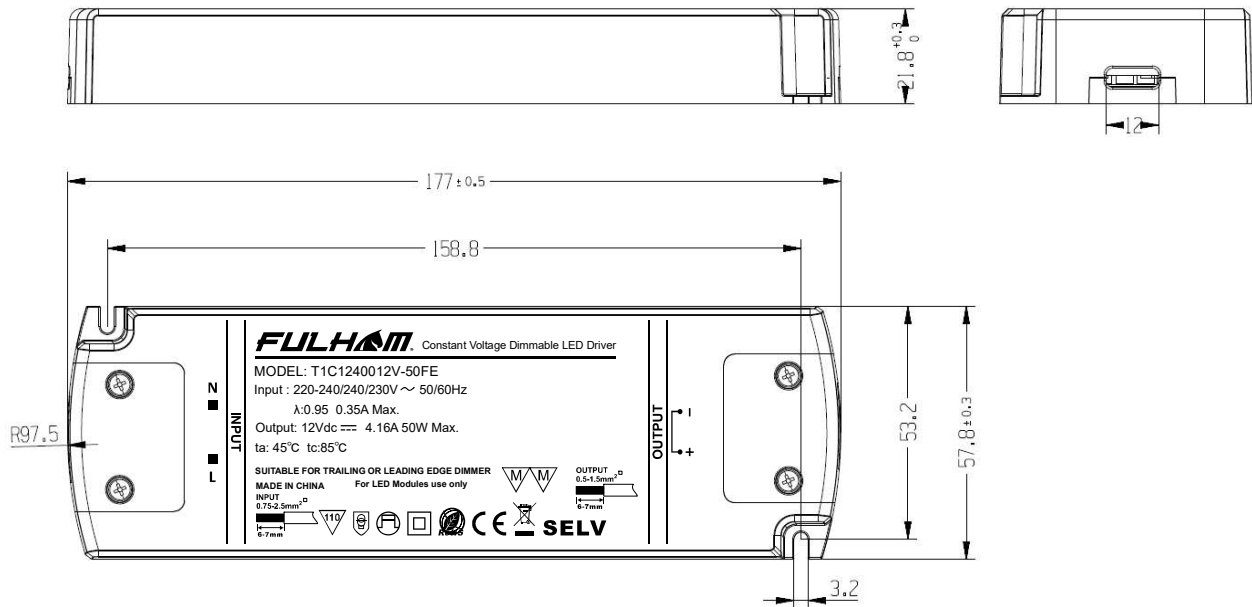

Note : All Dimensions are in mm.

Tolerance=±0.5mm

Packaging

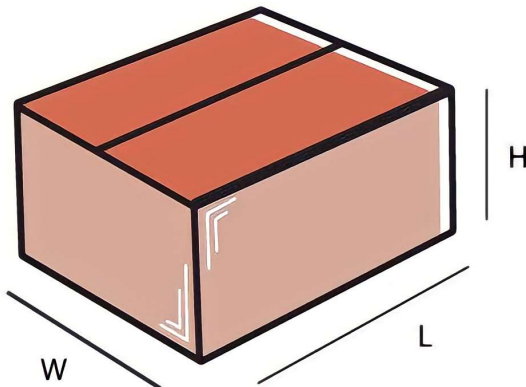

Master carton

OUTER DIMENSION		
L	W	H
315mm	180mm	255mm
Net Weight	Gross Weight	QUANTITY
		10 pc.

Fulham extends a limited warranty only to the original purchaser or to the first user for a period of 5 years @ Tc 75°C from the date of manufacture when properly installed and operated under normal conditions of use. For complete terms and conditions, please reference the Fulham Product Catalog (www.fulham.com). Due to a program of continuous improvement, Fulham reserves the right to make modifications or variations in design or construction to the equipment described. © Fulham Company Limited, All Rights Reserved.