



Planned Phase Out

Limited Stock Available While Supplies Last



VKMUNV025RDxxxA



UNV DC Engines Retrofit Kits with 0-10V Dimming

- Universal Voltage (120~277) DC Engine
- Suitable for open or fully enclosed luminaires
- Suitable for luminaires with plastic and glass lenses
- Class 2 design 143lm/W at system level
- cULus Classified 1598C
- cULus Recognized 8750
- Energy Star Luminaire 2.1 Listed and CSD ^①

General Specifications

Input Voltage ^②	120~277VAC (+/- 10%)
Input Current ^②	~0.233A @120V ~0.101A @277V
Input Power ^②	28W
Input PF	>0.98
THD	<20%
Input Frequency	50/60Hz
Module Operating Voltage	34.7VDC
Max Lumen Output @ Full Power ^②	4015 lumens @ 4000K / 80 CRI
Dimming Type/Range	0-10V / 100% ~ 10%
Beam Angle	120°
CRI	80 (standard), 90 available (MTO)
Storage Temperature Range	-35°C to 100°C / -31°F to 212°F
Operating Ambient Temperature Range (Ta)	-35°C to 60°C / -31°F to 140°F
Maximum Driver Case Temperature: per UL/ 5 year warranty	90°C (194°F) / 76°C (176°F)
Maximum Module Case Temperature	L70: Tc max=105°C (Ts=110°C) / L90: Tc max=105°C (Ts=110°C)
Estimated Lumen Maintenance (at Max Tc)	L70= >60,000 hours / L90= 40,000 hours
Color Consistency	Binning per ANSI C78.377-2015 @25°C; 3 SDCM
Inrush Current / Duration	20A @ 277V / 250us
Line Regulation / Load Regulation	<1% @100% Load / <3% @100% Load
Total Overall Ripple LF (<300Hz)/ HF(<40kHz) peak to peak	<5% @100% Load
Low Frequency Ripple (120Hz ripple peak to peak)	<5% @100% Load
Flicker Percentage	<7% @100% - 20% Dimming Range <5% @<20% Dimming Range
Start-up Time / Standby Power	<500ms / <0.5W No Load
Overall Size	7.83"Dia. x 1.18"H (199mm Dia. x 29.89mm H)
Wire Type/ Length	18AWG / 12" Black and White wires (Input 120~277VAC) 18AWG / 12" Pink and Purple wires (Dimming 0-10VDC)
LED Quantity	72 Pcs.
Driver Part Number	T1M1UNV0700-30L
Module Part Number	VMU095034RDxxxA
Weight	320g / 0.71lbs.
Packaging: Master Carton	20pcs
Maximum Screw Installation Torque	35in-lb (560in-ozf)
Safety/Compliance	Component: cURus Module File #E351548; Driver File #E342838 DC Engines Retrofit Kits: cULus Classified 1598C File # E365124 RoHS Compliant Dry and Damp Location Energy Star Luminaire 2.1 Listed and CSD ^①
RFI/EMI	FCC Part 15B Consumer, EN55015
Input Surge Test	2.5kV Common and Differential mode (Per ES Ring Wave Test)
Sound Rating / Noise	A / <24 dBA
Output Type	Class 2 (approved for luminaires glass or plastic lenses)
PCB Material / Connector Qty / Em. Connection	CEM1 / 2 / Yes
Warranty	5 years @ Max. Tc 105°C (module) and 76°C (Driver) from the date of manufacture

^① See page #4 "Certification Chart" for exact models.

^② Measured electrical data per UL file

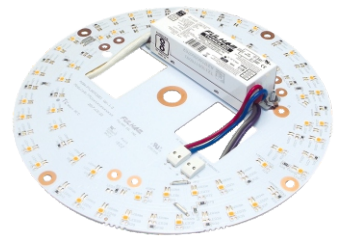

VKMUNV025RDxxxA



Typical Characteristics Graphs: Dimming and Thermal

Figure 1

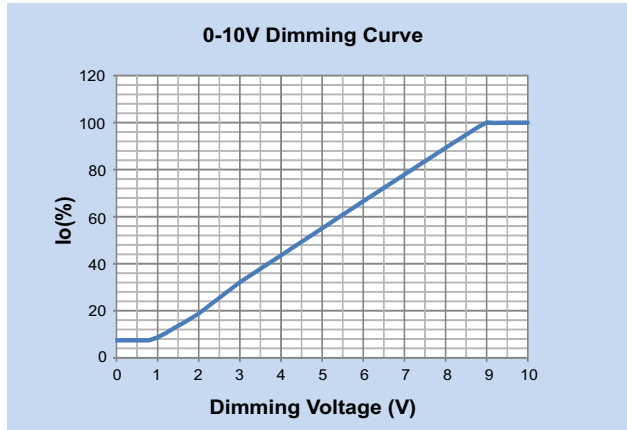
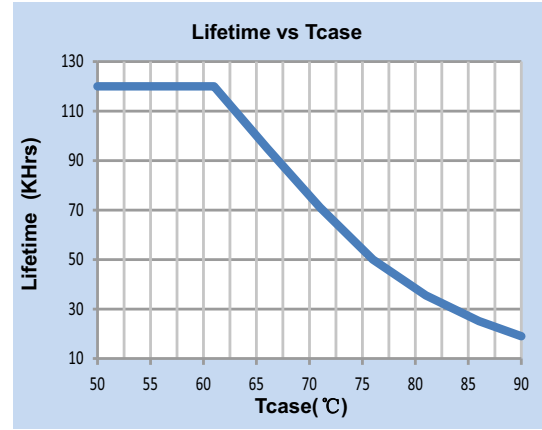

Figure 2



Failure Rate Info based upon MTBF modeling:
90% survivals at end of life @ <=Tc lifetime rating



VKMUNV025RDxxxA



Electrical and Optical Specifications

Color Temperature	DC Engine Retrofit Kit Part Number	Input Power	Nominal Luminous Flux @ 90 CRI	Engine Efficacy @ 90 CRI	Nominal Luminous Flux @ 80 CRI	Engine Efficacy @ 80 CRI
2700K	VKMUNV025RD827A	28W	3105 lumens	111 lm/W	3710 lumens	133 lm/W
3000K	VKMUNV025RD830A	28W	3355 lumens	120 lm/W	3820 lumens	136 lm/W
3500K	VKMUNV025RD835A	28W	3330 lumens	119 lm/W	3875 lumens	138 lm/W
4000K	VKMUNV025RD840A	28W	3415 lumens	122 lm/W	4015 lumens	143 lm/W
5000K	VKMUNV025RD850A	28W	3470 lumens	124 lm/W	4070 lumens	145 lm/W
5700K	VKMUNV025RD857A	28W	3470 lumens	124 lm/W	4070 lumens	145 lm/W
6500K	VKMUNV025RD865A	28W	3415lumens	122 lm/W	4015 lumens	143 lm/W

NOTES:

- 1) Electrical and optical specifications are based on Tc mod = 25°C. Reference Amb. Temp. vs Rel. Lum. Flux for other temperatures.
- 2) Nominal luminous flux at 90 CRI are calculated values, not measured.
- 3) Performance for these components have been tested in accordance with Energy Star.
- 4) Refer to Energy Star CSD or Luminaires 2.1 for actual measurements on specific part numbers. Energy Star testing is done at elevated case temperature.
- 5) Specifications are subject to change without notice.
- 6) 70CRI is NOT available.



VKMUNV025RDxxxA



Thermal Specifications

③ DC Engine Retrofit Kit (A)

Storage Temperature Range	-35°C to 100°C / -31°F to 212°F
Operating Ambient Temperature Range	-35°C to 60°C / -31°F to 140°F
Maximum Driver Case Temperature	90°C / 194°F
Maximum Module Case Temperature	L70 = 105°C (221°F) / L90 = 105°C (221°F)

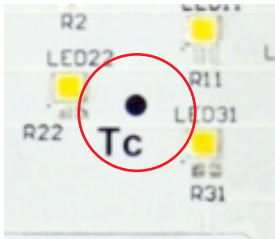

Tc located on module



Tc located on driver

Thermal De-Rating: Tc vs. Luminous Flux

Module Case Temperature (Tc)	Total Vf Multiplier	Luminous Flux Multiplier
25°C	1.000	1.000
30°C	1.000	0.991
35°C	0.997	0.982
40°C	0.993	0.973
45°C	0.993	0.964
50°C	0.990	0.953
55°C	0.987	0.944
60°C	0.987	0.935
65°C	0.984	0.926
70°C	0.984	0.917
75°C	0.980	0.908
80°C	0.977	0.899
85°C	0.977	0.889
90°C	0.974	0.880
95°C	0.970	0.862
100°C	0.967	0.853

NOTES:

- 1) Refer to DC Engine Retrofit Kit Installation Instructions for further detail.
- 2) This DC Engine Retrofit Kit can retrofit any luminaire with a dimension/volume greater or equal to the minimum dimensions shown below and on the Installation Instructions.
- 3) This DC Engine Retrofit Kit can be used with luminaires similar to the one illustrated on the Installation Instructions.

③ Suitable for surface mounted luminaire with minimum dimensions or volume: 10" diameter with a height of 3" or 30 cubic inches

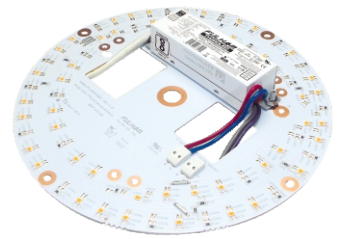

VKMUNV025RDxxxA



Certification Chart

Energy Star™ TM-21 Calculator Data

Model	VKMUNV025RDxxxA
Classification	
	YES
	YES (Driver & Module)
	YES
	YES
	YES

Tc Module	Reported L70	Reported L90
55°C	>60,000 Hrs	>54,000 Hrs
85°C	>60,000 Hrs	46,000 Hrs
105°C	>60,000 Hrs	40,000 Hrs
Tc Module	Calculated L70	Calculated L90
55°C	180,000 Hrs	54,000 Hrs
85°C	154,000 Hrs	46,000 Hrs
105°C	133,000 Hrs	40,000 Hrs

NOTES:

1) Energy Star CSD:

https://www.energystar.gov/products/lighting_fans/certified_lighting_subcomponent_database_csd

2) Energy Star Listed:

https://www.energystar.gov/productfinder/product/certified-light-fixtures/results?scrollTo=342&search_text=fulham&fixture_type_isopen=&markets_filter=United+States&zip_code_filter=&product_types=Select+a+Product+Category&sort_by=light_output_lumens&sort_direction=asc&page_number=0&lastpage=0

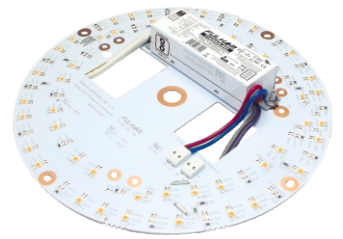

VKMUNV025RDxxxA



Mechanical Drawings

(Scale 3 : 5)

TOP VIEW

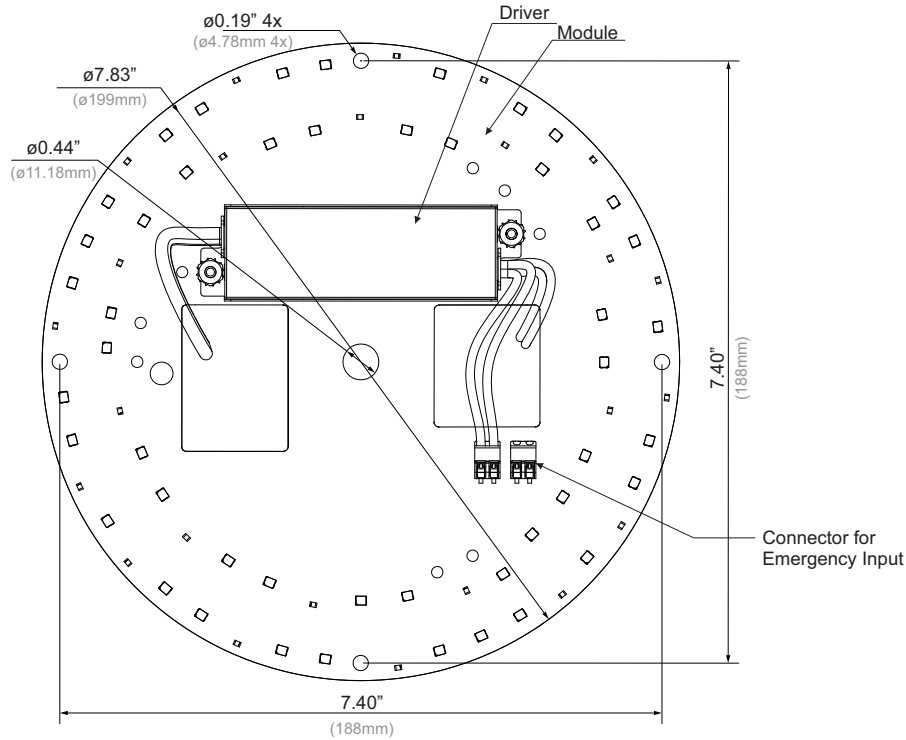

Overall Dimensions	
Diameter	7.83" [199mm]
Height	1.18" [29.89mm]
Wire Length	
AC Input (Black / White)	12" [304.8mm]
0-10V Dimming Purple (10v+) Pink (10V-)	12" [304.8mm]

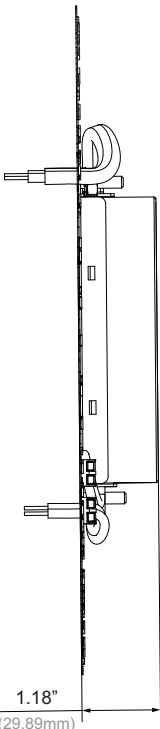

SIDE VIEW

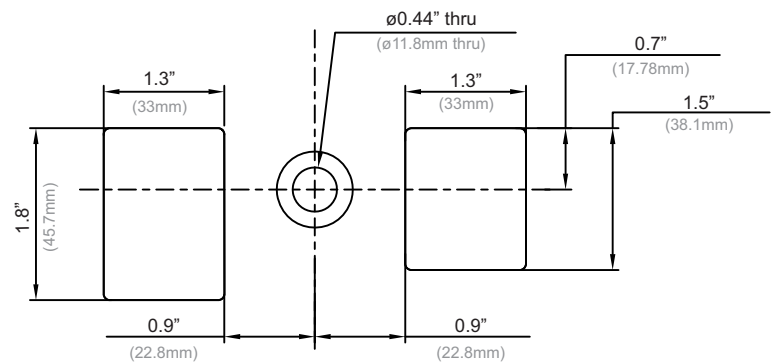

PARTIAL VIEW

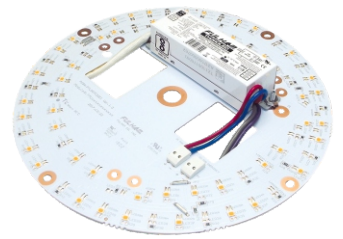

VKMUNV025RDxxxA



DC Engine Retrofit Kit Equivalency Chart: FLUO to LED

DC Engine Retrofit Kit (7.8" Round)				CFL					
DC Engine Retrofit Kit Part Number	System Wattage	Lumen Output	Efficacy	CFL Style	Lamp Wattage	# of Lamps	Total Wattage	Lumen Output	Efficacy
VKMUNV025RDxxxA	28W	4015 lm (4K/80CRI)	143 lm/W	Quad	13W	1	13W	775 lm	59 lm/W
					18W	1	18W	1075 lm	
				Triple	13W	1	13W	825 lm	63 lm/W
					18W	1	18W	1020 lm	
				Quad	13W	2	26W	1550 lm	59 lm/W
					26W	1	26W		
				Triple	13W	2	26W	1650 lm	63 lm/W
					26W	1	26W	1536 lm	
				Circline T5	22W	1	22W	1530 lm	69 lm/W
				Circline T9	22W	1	22W	775 lm	35 lm/W

NOTES:

- 1) LED is a point source and FLUO is 360, there is more light lost with FLUO especially during the reflection. Therefore it is recommended to use a 65 percent of the original light source total lumens when converting FLUO to LED. For example original FLUO lumens of 2000 x .65% = 1300 LED lumens. This is only a recommendation, and the installer should consider other factors for the application.
- 2) For reference only, several factors apply.



VKMUNV025RDxxxA



DC Engine Retrofit Kit with Emergency Options

NOTE: Emergency systems are not UL classified for field installation.

Engine/Kit Part Number	Emer. Driver Part Number	Battery Wattage	Battery Part Number	Harness (mA)	LED Vf (V)	LED If (mA)	Total Power (W)	Total Lum. Output (lm)	Eff. (lm/W)
VKMUNV025RD840A	FHS2-UNV-36L/ FHS2-UNV-56S	4W	FHSBATT8-AA9 FHSBATL3-1	FHS-HARNESS-125	32.0	125	4.0	775 [Ⓢ]	194
	FHSCP-UNV-5WL	5W	N/A	N/A	32.2	156	5.0	965	193
	FHSCP-UNV-10P-L-SD	5W	FHSBATL3-1.5-SD	N/A	32.2	156	5.0	965	193
	FHS2-UNV-36L	6W	FHSBATL6-6	FHS-HARNESS-175	32.3	175	5.6	1080 [Ⓢ]	191
	FHSCP-UNV-10P-L-SD	6W	FHSBATL9-6-SD	N/A	32.4	186	6.0	1147	191
	FHSCP-UNV-7.8WL	7.8W	N/A	N/A	32.6	240	7.8	1472	189
	FHS2-UNV-36L/ FHS2-UNV-56S	8W	FHSBATL3-1.5 FHSBATL3-1.5S	FHS-HARNESS-225	32.6	225	7.3	1382 [Ⓢ]	188
	FHS2-UNV-36L	10W	FHSBATL9-6	FHS-HARNESS-300	33.0	300	9.9	1828 [Ⓢ]	185
	FHSCP-UNV-10P-L-SD	10W	FHSBATL3-3-SD FHSBATL6-1.5L-SD [Ⓢ]	N/A	33.0	303	10.0	1846	185
	FHSCP-UNV-10.7WL	10.7W	N/A	N/A	33.1	324	10.7	1986	184
	FHSCP-UNV-13.7WL	13.7W	N/A	N/A	33.5	408	13.7	2451	179
	FHS2-UNV-36L/ FHS2-UNV-56S	16W	FHSBATL3-3	FHS-HARNESS-450	33.6	450	15.1	2687 [Ⓢ]	178
	FHSCP-UNV-17WL	17W	N/A	N/A	33.8	501	17.0	2967	175
	FHS2-UNV-36L/ FHS2-UNV-56S	20W	FHSBATL6-3	FHS-HARNESS-550	34.1	550	18.7	3230 [Ⓢ]	172

NOTES:

- 1) For reference only, several factors apply.
- 2) Emergency systems are not UL classified for field installation.
- Ⓢ These batteries do not include mounting means, separate mounting brackets are available
- Ⓢ Initial lumen output. Will reduce to no less than ~65% of total lumen output.

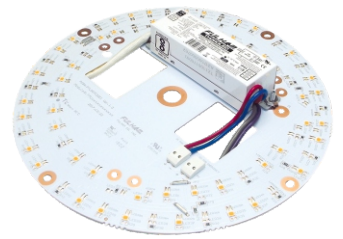

VKMUNV025RDxxxA



Wiring Diagram: Standard Option

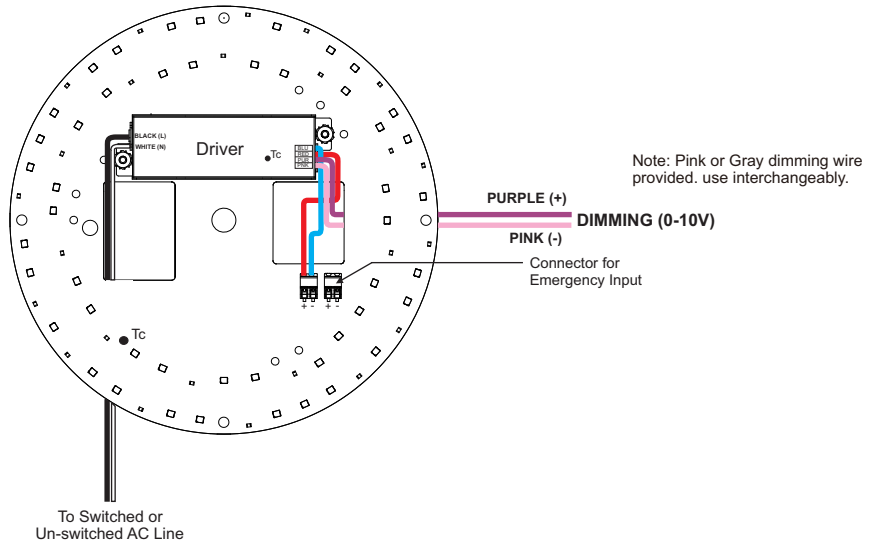

Wiring Diagram: HotSpot2 (FHS2) EM- Pass Through (Recommended for non-Fulham LED EM)

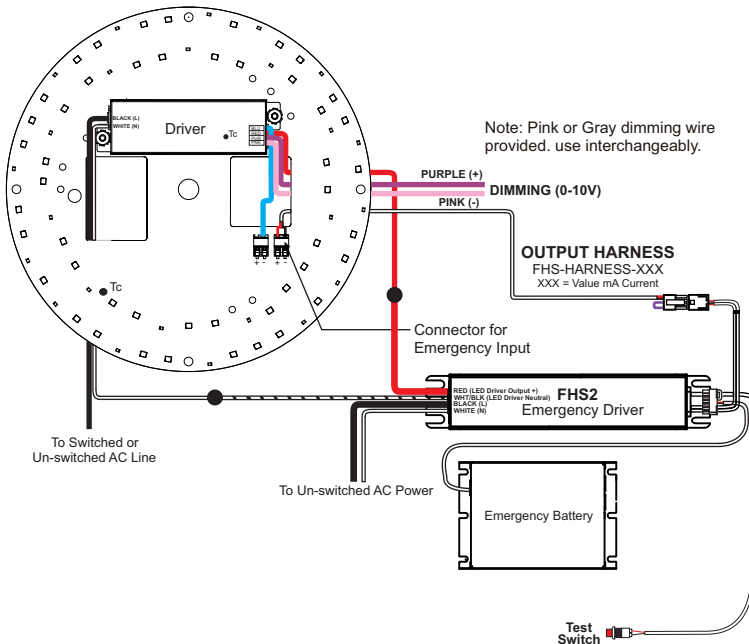

Wiring Diagram: HotSpot2 (FHS2) EM- In Parallel (Recommended for Fulham LED EM)

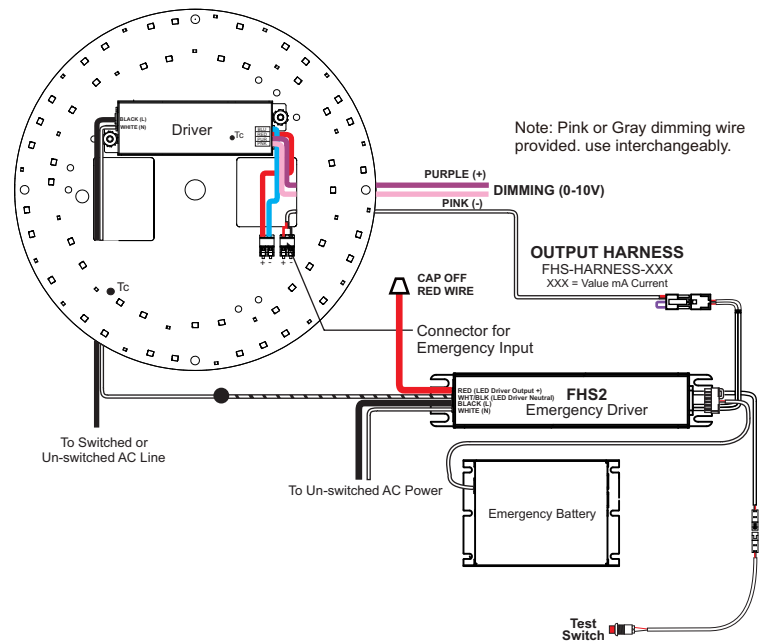

NOTES:

- 1) For reference only, several factors apply.
- 2) Emergency systems are not UL classified for field installation.

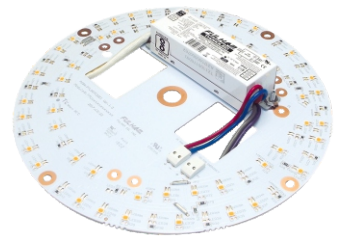

VKMUNV025RDxxxA



Wiring Diagram: Constant Power with conduit (FHSCP) EM- Pass Through (Recommended for non-Fulham LED EM)

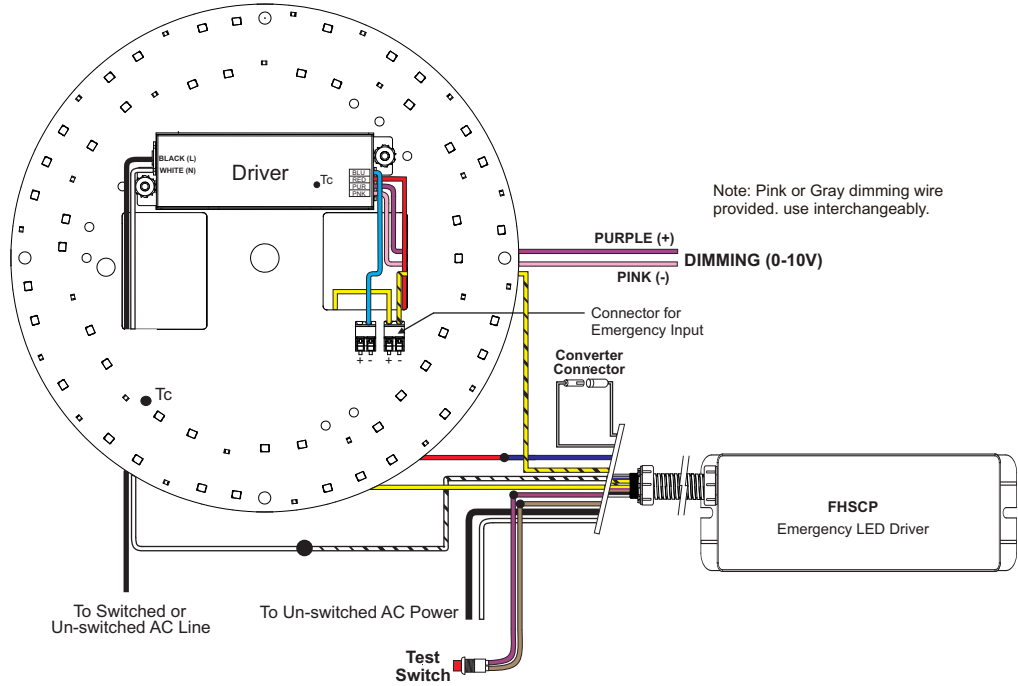

Wiring Diagram: Constant Power with conduit (FHSCP) EM- In Parallel (Recommended for Fulham LED EM)

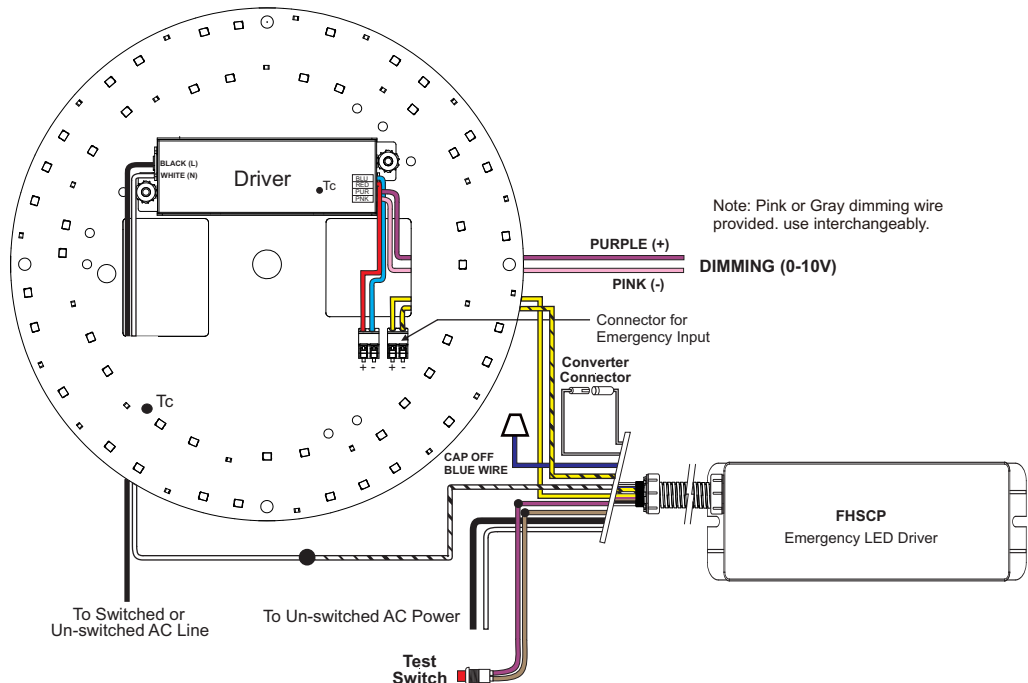

NOTES:

- 1) For reference only, several factors apply.
- 2) Emergency systems are not UL classified for field installation.

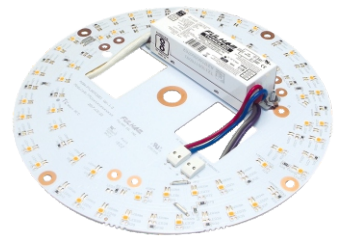

VKMUNV025RDxxxA



Wiring Diagram: Parallel Wiring (FHSCP-UNV-10P-L-SD)

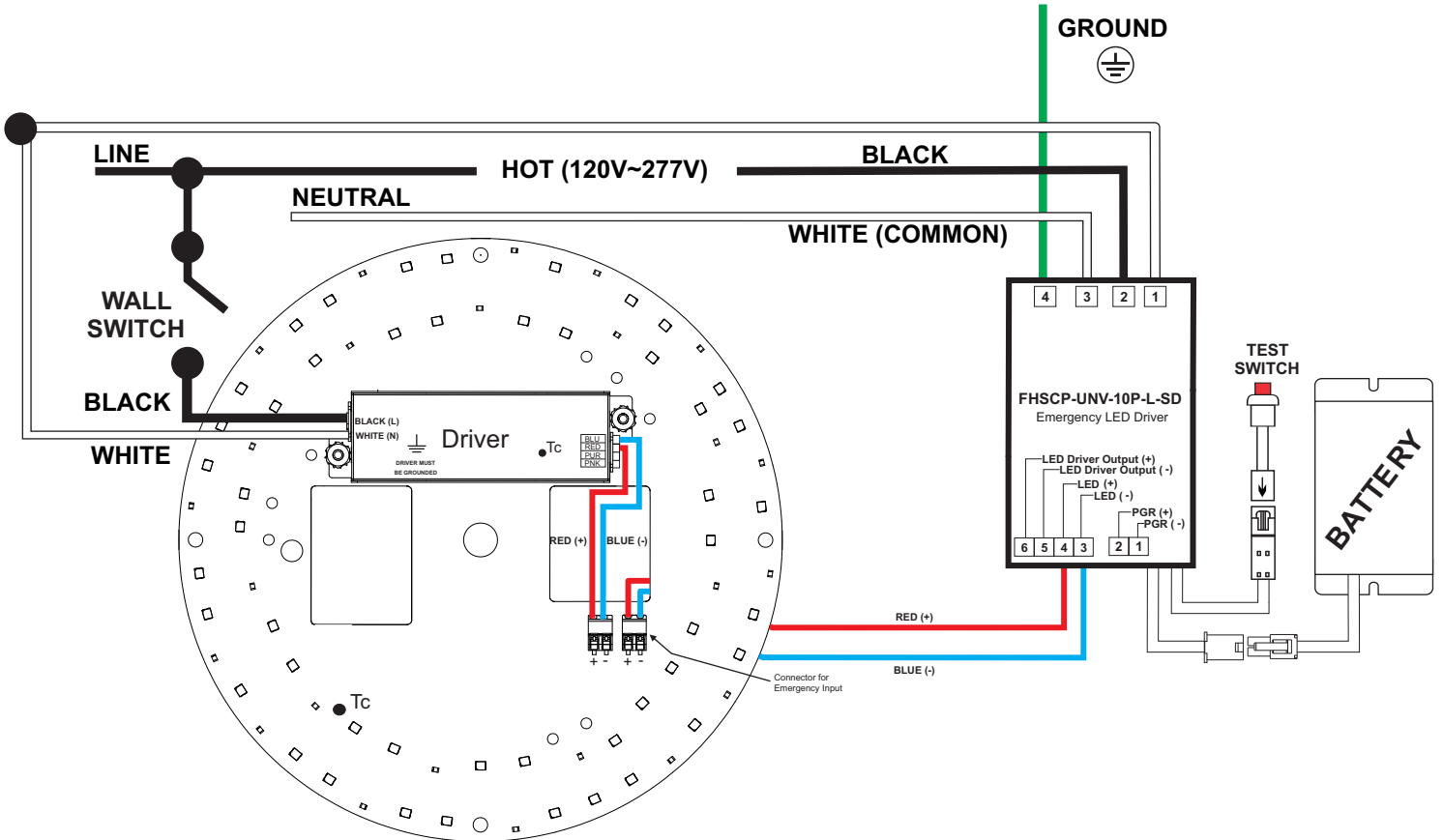

NOTES:

- 1) For reference only, several factors apply.
- 2) Emergency systems are not UL classified for field installation.

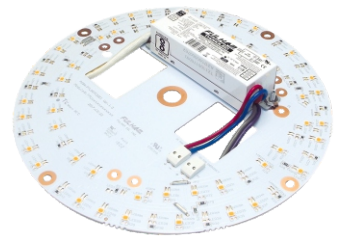

VKMUNV025RDxxxA



Color and Binning

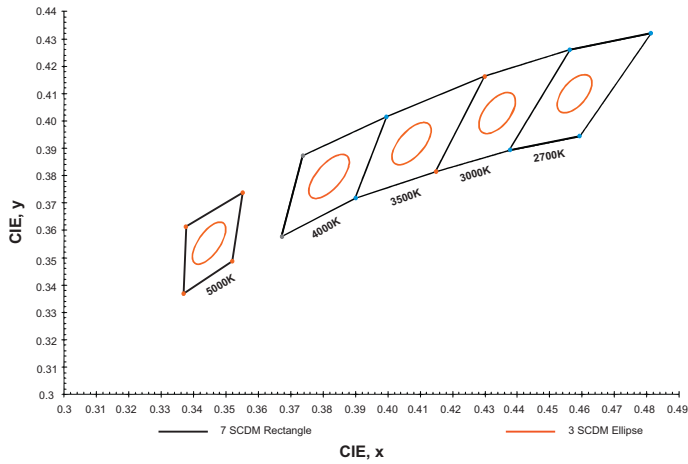

Optical Spectrum

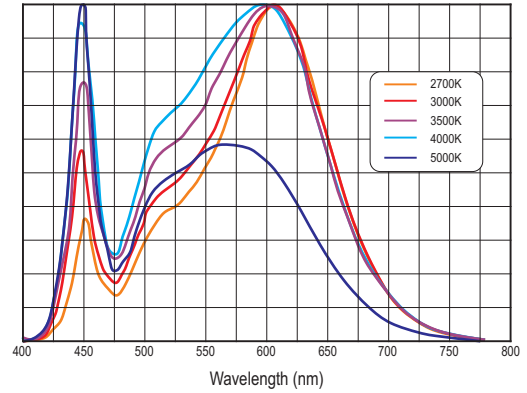

NOTES:

- 1) The Color and Binning and Optical Spectrum charts are for reference only. For more detailed info, contact factory.
- 2) Reference Samsung Chromaticity Diagram for Color and Binning. Binning per ANSI C78.377-2015 @ 25°C; 3 SDCM.
- 3) The Optical Spectrum values vary depending on product type and color rank.

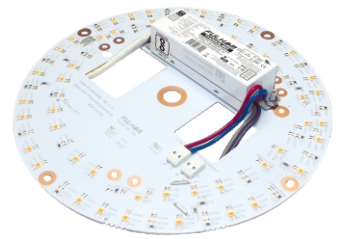

VKMUNV025RDxxxA



Guidelines

Reduced Flicker Operation Feature

- DC Engine models have added circuitry to help reduce the Flicker when operated on the 50/60Hz power lines. The Flicker percentage on these models is below 30% when operated at line voltage, per CEC requirement.

Termination Notes

- A luminaire disconnect UL listed connector is included, as part of DC Engine Retrofit Kit to meet Energy Star requirements.
- Use solid wire size 18AWG/12" per pole, rated at max 600V load and 105°C operating temperature.
- Strip wires to 11-13mm (0.47in.).
- Connector not for multiple use.
- For additional information on Wago's 873 Series Lumi-Nuts® connector, please visit: http://www.wago.com/infomaterial/wago_ebook/51261593/flipviewerexpress.html



Environmental Rating

- DC Engine Retrofit Kit are rated for dry and damp locations.

Fastening to Luminaire

- When installing by "mounting thru holes" (recommended), use any screw with diameter less than 0.13in. [3.4mm]. Mount on a flat surface and use all 4 mounting holes to ensure good contact between back side of DC Engine Retrofit Kit and mounting surface. Refer to max specified torque for installation. Suggested screw sizes: #5 or M3 Pan Head screw.

Electrostatic Sensitive Product (ESD)

- Fulham LED products should be handled with proper measures to protect against any potential ESD damage.
- When servicing, personnel should be ground and direct contact with LED should be avoided.

Thermal Management

- Proper thermal management should be employed to ensure life and reliability of product.

Wiring

- Intended for UNV (120-277V) application ONLY.
- Connect the Black wire from the DC Engine Retrofit Kit to the building Line by using the proper connectors or wire nuts.
- Connect the White wire from the DC Engine Retrofit Kit to the building/source Neutral by using the proper connectors or wire nuts.
- DC Engine Retrofit Kit and luminaire must be grounded.

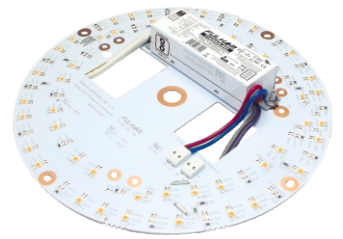

VKMUNV025RDxxxA



Part Number Matrix

V **K** **M** **UNV** **025** **RD** **8** **40** **A**

Product Line
 V = Vizion
Compliance
 K = DC Engine Retrofit Kit (cULus Classified)
Dimming
 M = 0-10V
Input Voltage
 UNV = 120V~277V
Estimated Power
 025 = 25W
Shape
 RD=Round
CRI
 8 = 80
 9 = 90
Color Temperature
 27 = 2700K
 30 = 3000K
 35 = 3500K
 40 = 4000K
 50 = 5000K
 57 = 5700K
 65 = 6500K
Material
 A = CEM1

① Standard Product offering, in addition to 90CRI / 3000K. (All other options are made to order with MOQ and lead time).
 ② DC Engine Retrofit Kit includes mounting hardware, retrofit labels, and installation instructions.

Product Image: 25W Round DC Engine Kit

VKMUNV025RDxxxA

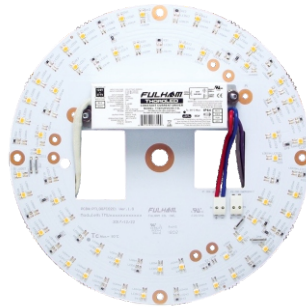

This luminaire has been modified and can no longer operate the originally intended lamp. Ce luminaire a été modifié et ne peut plus utiliser la lampe prévue à l'origine.



Hardware Kit: TLC-HW08

UNV DC Engines Retrofit Kits with 0-10V Dimming :
 Hardware, Quick disconnect, Labels & Installation Instructions

Packaging

Master Carton

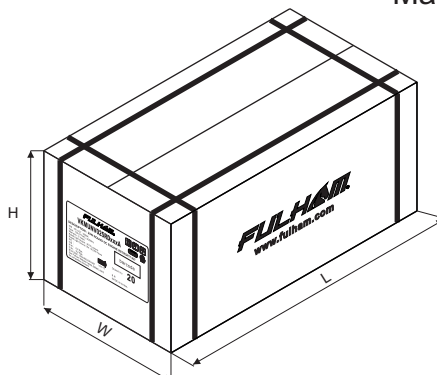

OUTER DIMENSION		
L	W	H
21.65"(550mm)	15.75"(400mm)	9.45"(240mm)
Net Weight	Gross Weight	QUANTITY
14.52 lbs. (6.6 kg)	20.24 lbs. (9.2 kg)	20pcs.