

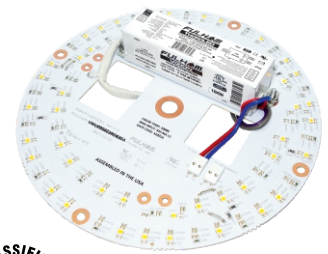

Planned Phase Out

Limited Stock Available While Supplies Last



VKMUNV018RDxxxA

UNV DC Engines Retrofit Kits with 0-10V Dimming

- Universal Voltage (120~277) DC Engine
- Suitable for open or fully enclosed luminaires
- Suitable for luminaires with plastic and glass lenses
- Class 2 design 141lm/W at system level
- cULus Classified 1598C
- cULus Recognized 8750
- Energy Star Luminaire 2.1 Listed and CSD ^①

General Specifications

Input Voltage ^②	120~277VAC (+/- 10%)
Input Current ^②	~0.166A @120V ~0.072A @277V
Input Power ^②	20W
Input PF	>0.98
THD	<20%
Input Frequency	50/60Hz
Module Operating Voltage	23.1VDC
Max Lumen Output @ Full Power ^②	2675 lumens @ 4000K / 80 CRI
Dimming Type/Range	0-10V / 100% ~ 10%
Beam Angle	120°
CRI	80 (standard), 90 available (MTO)
Storage Temperature Range	-35°C to 100°C / -31°F to 212°F
Operating Ambient Temperature Range (Ta)	-35°C to 60°C / -31°F to 140°F
Maximum Driver Case Temperature: per UL/ 5 year warranty	90°C (194°F) / 76°C (176°F)
Maximum Module Case Temperature	L70: Tc max=105°C (Ts=110°C) / L90: Tc max=105°C (Ts=110°C)
Estimated Lumen Maintenance (at Max Tc)	L70= >60,000 hours / L90= 40,000 hours
Color Consistency	Binning per ANSI C78.377-2015 @25°C; 3 SDCM
Inrush Current / Duration	20A @ 277V / 250us
Line Regulation / Load Regulation	<1% @100% Load / <3% @100% Load
Total Overall Ripple LF (<300Hz)/ HF(<40kHz) peak to peak	<5% @100% Load
Low Frequency Ripple (120Hz ripple peak to peak)	<5% @100% Load
Flicker Percentage	<7% @100% - 20% Dimming Range <5% @<20% Dimming Range
Start-up Time / Standby Power	<500ms / <0.5W No Load
Overall Size	7.83"Dia. x 1.18"H (199mm Dia. x 29.89mm H)
Wire Type/ Length	18AWG / 12" Black and White wires (Input 120~277VAC) 18AWG / 12" Pink and Purple wires (Dimming 0-10VDC)
LED Quantity	48 Pcs.
Driver Part Number	T1M1UNV0700-30L
Module Part Number	VMU095023RDxxxA
Weight	320g / 0.71lbs.
Packaging: Master Carton	20pcs
Maximum Screw Installation Torque	35in-lb (560in-ozf)
Safety/Compliance	Component: cURus Module File #E351548; Driver File #E342838 DC Engines Retrofit Kits: cULus Classified 1598C File # E365124 RoHS Compliant Dry and Damp Location Energy Star Luminaire 2.1 Listed and CSD ^①
RFI/EMI	FCC Part 15B Consumer, EN55015
Input Surge Test	2.5kV Common and Differential mode (Per ES Ring Wave Test)
Sound Rating / Noise	A / <24 dBA
Output Type	Class 2 (approved for luminaires glass or plastic lenses)
PCB Material / Connector Qty / Em. Connection	CEM1 / 2 / Yes
Warranty	5 years @ Max. Tc 105°C (module) and 76°C (Driver) from the date of manufacture

^① See page #4 "Certification Chart" for exact models.

^② Measured electrical data per UL file

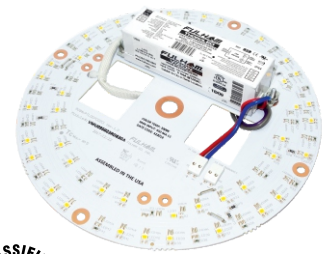

VKMUNV018RDxxxA



Typical Characteristics Graphs: Dimming and Thermal

Figure 1

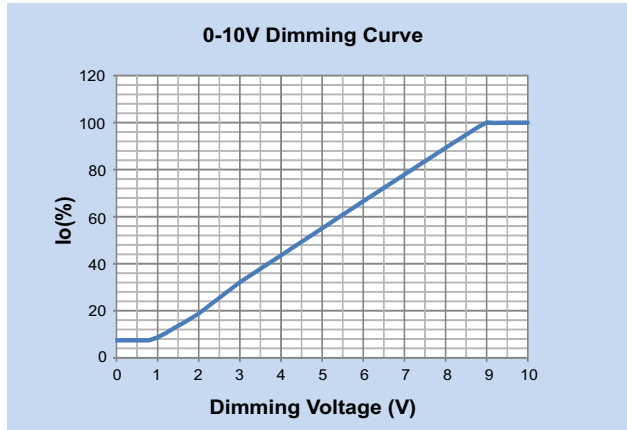
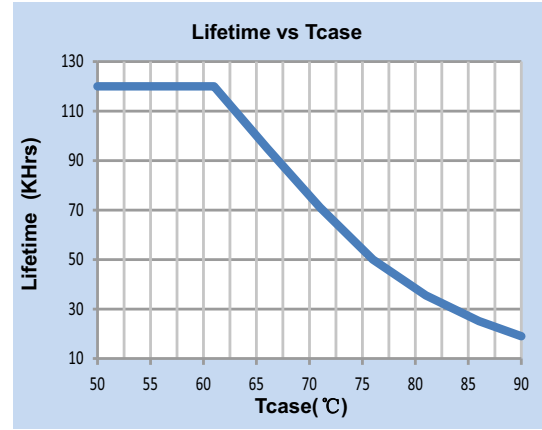
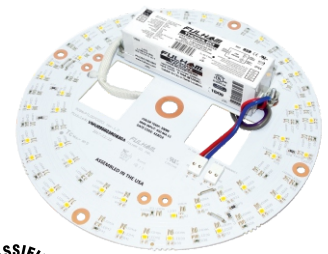

Figure 2



Failure Rate Info based upon MTBF modeling:
90% survivals at end of life @ <=Tc lifetime rating



VKMUNV018RDxxxA



Electrical and Optical Specifications

Color Temperature	DC Engine Retrofit Kit Part Number	Input Power	Nominal Luminous Flux @ 90 CRI	Engine Efficacy @ 90 CRI	Nominal Luminous Flux @ 80 CRI	Engine Efficacy @ 80 CRI
2700K	VKMUNV018RD827A	20W	2180 lumens	109 lm/W	2600 lumens	130 lm/W
3000K	VKMUNV018RD830A	20W	2360 lumens	118 lm/W	2680 lumens	134 lm/W
3500K	VKMUNV018RD835A	20W	2340 lumens	117 lm/W	2720 lumens	136 lm/W
4000K	VKMUNV018RD840A	20W	2400 lumens	120 lm/W	2820 lumens	141 lm/W
5000K	VKMUNV018RD850A	20W	2440 lumens	122 lm/W	2860 lumens	143 lm/W
5700K	VKMUNV018RD857A	20W	2440 lumens	122 lm/W	2860 lumens	143 lm/W
6500K	VKMUNV018RD865A	20W	2400 lumens	120 lm/W	2820 lumens	141 lm/W

NOTES:

- 1) Electrical and optical specifications are based on Tc mod = 25°C. Reference Amb. Temp. vs Rel. Lum. Flux for other temperatures.
- 2) Nominal luminous flux at 90 CRI are calculated values, not measured.
- 3) Performance for these components have been tested in accordance with Energy Star.
- 4) Refer to Energy Star CSD or Luminaires 2.1 for actual measurements on specific part numbers. Energy Star testing is done at elevated case temperature.
- 5) Specifications are subject to change without notice.
- 6) 70CRI is NOT available.

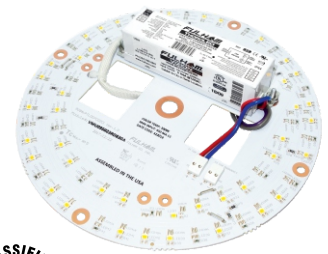

VKMUNV018RDxxxA



Thermal Specifications

③ DC Engine Retrofit Kit (A)

Storage Temperature Range	-35°C to 100°C / -31°F to 212°F
Operating Ambient Temperature Range	-35°C to 60°C / -31°F to 140°F
Maximum Driver Case Temperature	90°C / 194°F
Maximum Module Case Temperature	L70 = 105°C (221°F) / L90 = 105°C (221°F)

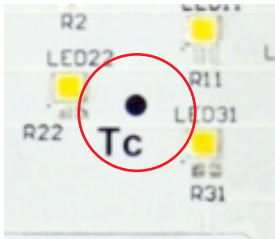

Tc located on module

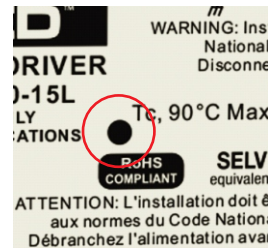

Tc located on driver

Thermal De-Rating: Tc vs. Luminous Flux

Module Case Temperature (Tc)	Total Vf Multiplier	Luminous Flux Multiplier
25°C	1.000	1.000
30°C	1.000	0.991
35°C	0.997	0.982
40°C	0.993	0.973
45°C	0.993	0.964
50°C	0.990	0.953
55°C	0.987	0.944
60°C	0.987	0.935
65°C	0.984	0.926
70°C	0.984	0.917
75°C	0.980	0.908
80°C	0.977	0.899
85°C	0.977	0.889
90°C	0.974	0.880
95°C	0.970	0.862
100°C	0.967	0.853

NOTES:

- 1) Refer to DC Engine Retrofit Kit Installation Instructions for further detail.
- 2) This DC Engine Retrofit Kit can retrofit any luminaire with a dimension/volume greater or equal to the minimum dimensions shown below and on the Installation Instructions.
- 3) This DC Engine Retrofit Kit can be used with luminaires similar to the one illustrated on the Installation Instructions.

③ Suitable for surface mounted luminaire with minimum dimensions or volume: 10" diameter with a height of 3" or 30 cubic inches

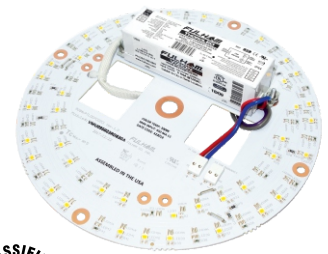

VKMUNV018RDxxxA



Certification Chart

Energy Star™ TM-21 Calculator Data

Model	VKMUNV018RDxxxA
Classification	
	YES
	YES (Driver & Module)
	YES
	YES
	YES

Tc Module	Reported L70	Reported L90
55°C	>60,000 Hrs	>54,000 Hrs
85°C	>60,000 Hrs	46,000 Hrs
105°C	>60,000 Hrs	40,000 Hrs
Tc Module	Calculated L70	Calculated L90
55°C	180,000 Hrs	54,000 Hrs
85°C	154,000 Hrs	46,000 Hrs
105°C	133,000 Hrs	40,000 Hrs

NOTES:

1) Energy Star CSD:

https://www.energystar.gov/products/lighting_fans/certified_lighting_subcomponent_database_csd

2) Energy Star Listed:

https://www.energystar.gov/productfinder/product/certified-light-fixtures/results?scrollTo=342&search_text=fulham&fixture_type_isopen=&markets_filter=United+States&zip_code_filter=&product_types=Select+a+Product+Category&sort_by=light_output_lumens&sort_direction=asc&page_number=0&lastpage=0



VKMUNV018RDxxxA



Mechanical Drawings

(Scale 3 : 5)

TOP VIEW

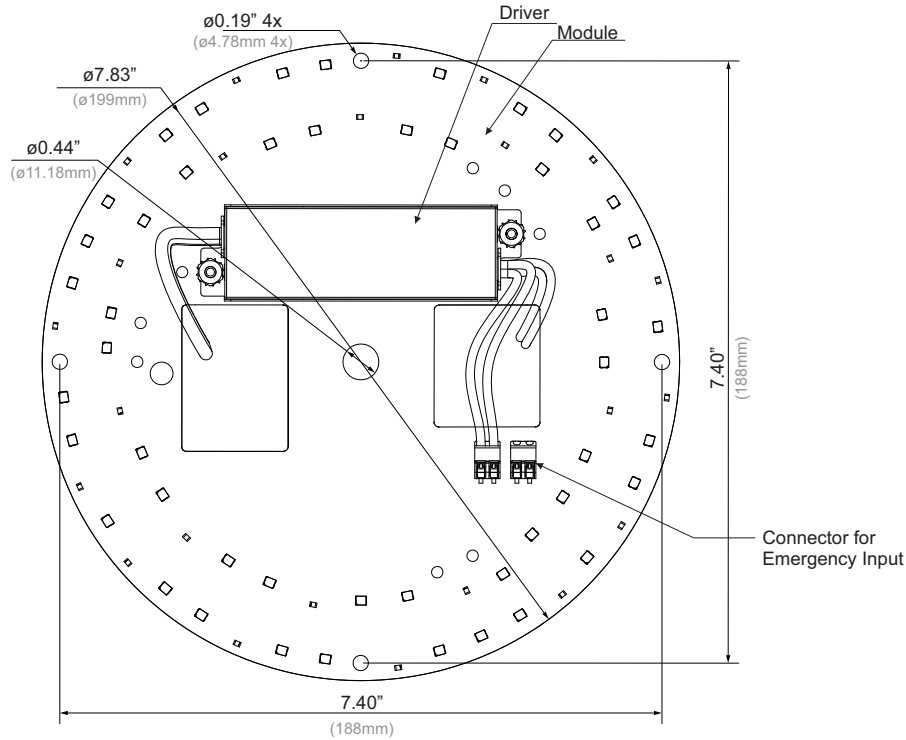

Overall Dimensions	
Diameter	7.83" [199mm]
Height	1.18" [29.89mm]
Wire Length	
AC Input (Black / White)	12" [304.8mm]
0-10V Dimming (Purple (10v+) Pink (10v-))	12" [304.8mm]

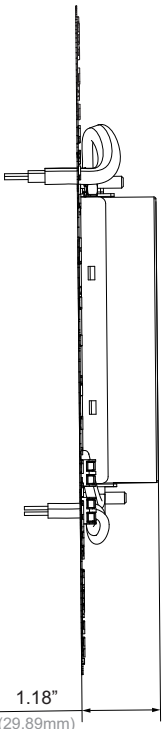

SIDE VIEW

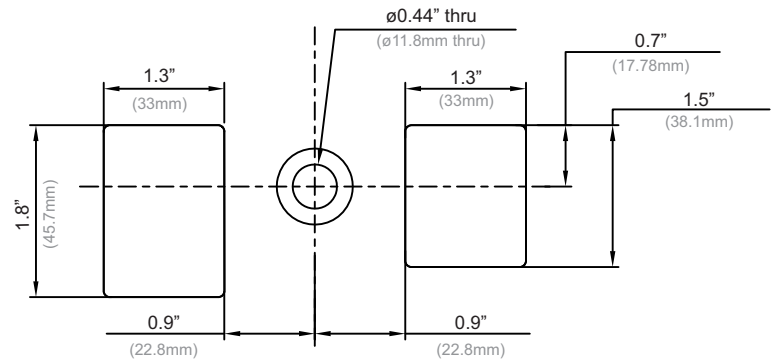

PARTIAL VIEW

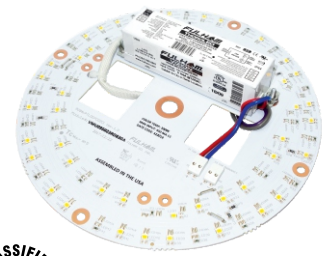

VKMUNV018RDxxxA



DC Engine Retrofit Kit Equivalency Chart: FLUO to LED

DC Engine Retrofit Kit (7.83" Round)				CFL					
DC Engine Retrofit Kit Part Number	System Wattage	Lumen Output	Efficacy	CFL Style	Lamp Wattage	# of Lamps	Total Wattage	Lumen Output	Efficacy
VKMUNV018RDxxxA	18W	2820 lm (4K/80CRI)	141 lm/W	Quad	13W	1	13W	775 lm	59 lm/W
					18W	1	18W	1075 lm	
				Triple	13W	1	13W	825 lm	63 lm/W
					18W	1	18W	1020 lm	
				Quad	13W	2	26W	1550 lm	59 lm/W
					26W	1	26W		
				Triple	13W	2	26W	1650 lm	63 lm/W
					26W	1	26W		
				Circline T5	22W	1	22W	1530 lm	69 lm/W
				Circline T9	22W	1	22W	775 lm	35 lm/W

NOTES:

- 1) LED is a point source and FLUO is 360, there is more light lost with FLUO especially during the reflection. Therefore it is recommended to use a 65 percent of the original light source total lumens when converting FLUO to LED. For example original FLUO lumens of 2000 x .65% = 1300 LED lumens. This is only a recommendation, and the installer should consider other factors for the application.
- 2) For reference only, several factors apply.

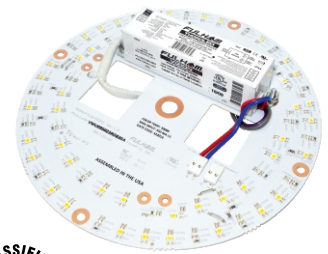

VKMUNV018RDxxxA



DC Engine Retrofit Kit with Emergency Options

NOTE: Emergency systems are not UL classified for field installation.

DC Engine Retrofit Kit Part Number	Emer. Driver Part Number	Battery Wattage	Battery Part Number	Harness (mA)	LED Vf (V)	LED If (mA)	Total Power (W)	Total Lum. Output (lm)	Eff. (lm/W)
VKMUNV018RD840A	FHS2-UNV-36L/ FHS2-UNV-56S	4W	FHSBATT8-AA9 FHSBATL3-1	FHS-HARNESS-175	21.5	175	3.8	720 [Ⓢ]	191
	FHSCP-UNV-5WL	5W	N/A	N/A	21.8	228	5.0	934	187
	FHSCP-UNV-10P-L-SD	5W	FHSBATL3-1.5-SD	N/A	21.8	228	5.0	934	187
	FHS2-UNV-36L	6W	FHSBATL6-6	FHS-HARNESS-250	21.8	250	5.5	1022 [Ⓢ]	187
	FHSCP-UNV-10P-L-SD	6W	FHSBATL9-6-SD	N/A	21.9	368	6.0	1124	187
	FHSCP-UNV-7.8WL	7.8W	N/A	N/A	22.2	354	7.8	1428	183
	FHS2-UNV-36L/ FHS2-UNV-56S	8W	FHSBATL3-1.5 FHSBATL3-1.5S	FHS-HARNESS-350	22.2	350	7.8	1412 [Ⓢ]	182
	FHS2-UNV-36L	10W	FHSBATL9-6	FHS-HARNESS-450	22.4	450	10.1	1791 [Ⓢ]	178
	FHSCP-UNV-10P-L-SD	10W	FHSBATL3-3-SD FHSBATL6-1.5L-SD [Ⓢ]	N/A	22.4	444	10.0	1769	177
	FHSCP-UNV-10.7WL	10.7W	N/A	N/A	22.5	474	10.7	1880	176
	FHSCP-UNV-13.7WL	13.7W	N/A	N/A	22.8	600	13.7	2328	170
	FHS2-UNV-36L/ FHS2-UNV-56S	16W	FHSBATL3-3	FHS-HARNESS-650	22.9	650	14.9	2496 [Ⓢ]	168
	FHSCP-UNV-17WL	17W	N/A	N/A	23.1	735	17.0	2772	163

NOTES:

- 1) For reference only, several factors apply.
- 2) Emergency systems are not UL classified for field installation.
- Ⓢ These batteries do not include mounting means, separate mounting brackets are available
- Ⓢ Initial lumen output. Will reduce to no less than ~65% of total lumen output.

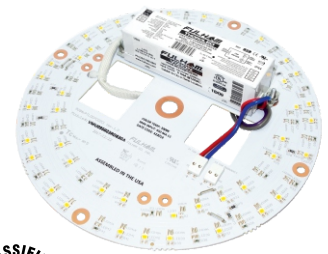

VKMUNV018RDxxxA



Wiring Diagram: Standard Option

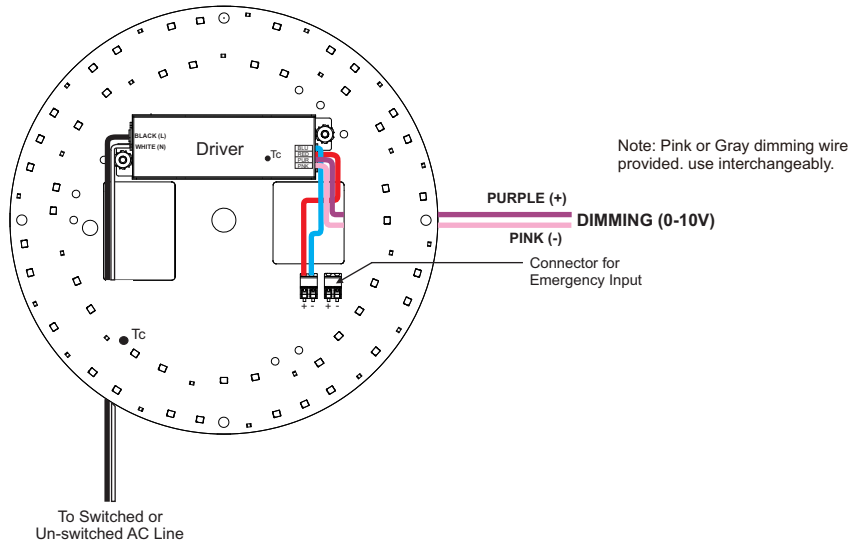

Wiring Diagram: HotSpot2 (FHS2) EM- Pass Through (Recommended for non-Fulham LED EM)

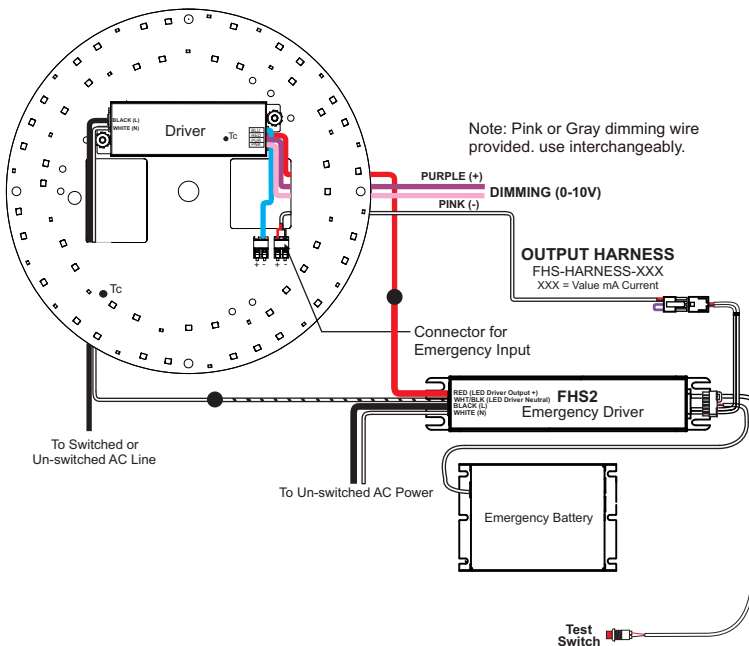

Wiring Diagram: HotSpot2 (FHS2) EM- In Parallel (Recommended for Fulham LED EM)

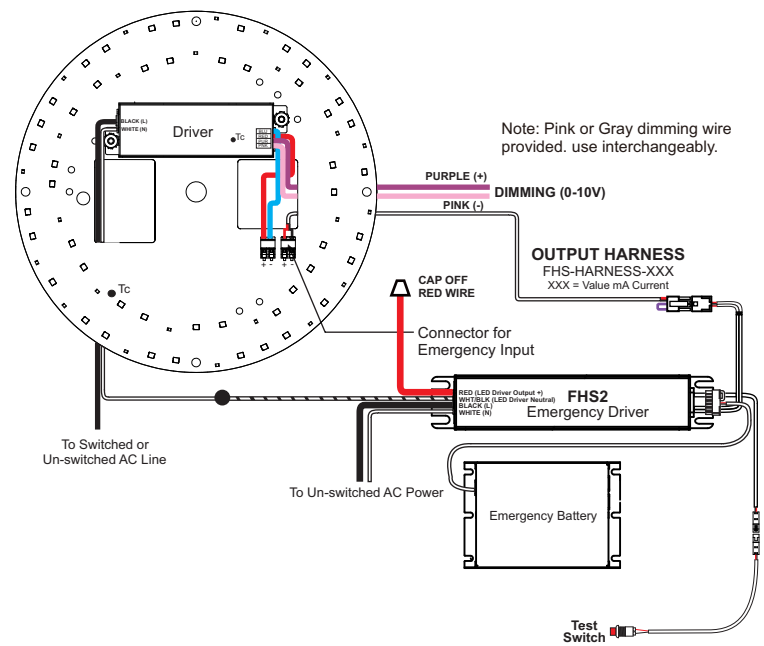

NOTES:

- 1) For reference only, several factors apply.
- 2) Emergency systems are not UL classified for field installation.

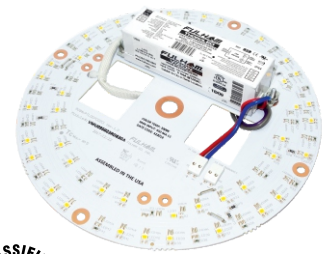

VKMUNV018RDxxxA



Wiring Diagram: Constant Power with conduit (FHSCP) EM- Pass Through (Recommended for non-Fulham LED EM)

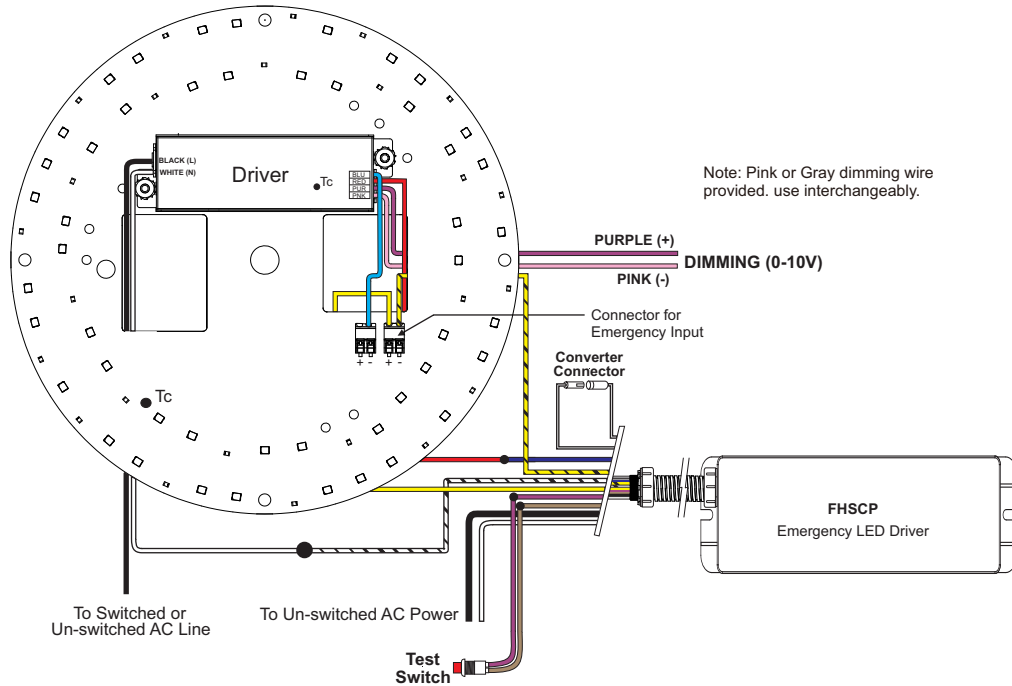

Wiring Diagram: Constant Power with conduit (FHSCP) EM- In Parallel (Recommended for Fulham LED EM)

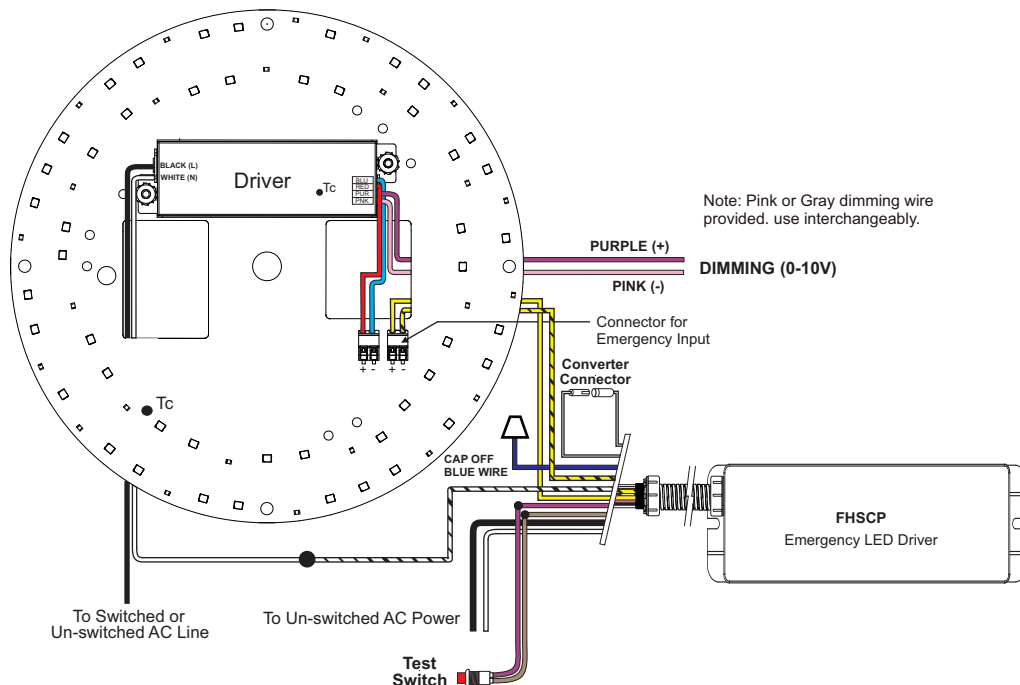

NOTES:

- 1) For reference only, several factors apply.
- 2) Emergency systems are not UL classified for field installation.

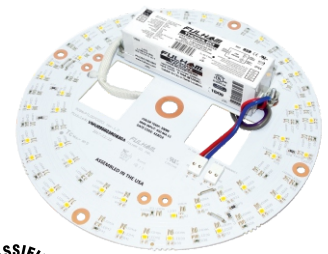

VKMUNV018RDxxxA



Wiring Diagram: Parallel Wiring (FHSCP-UNV-10P-L-SD)

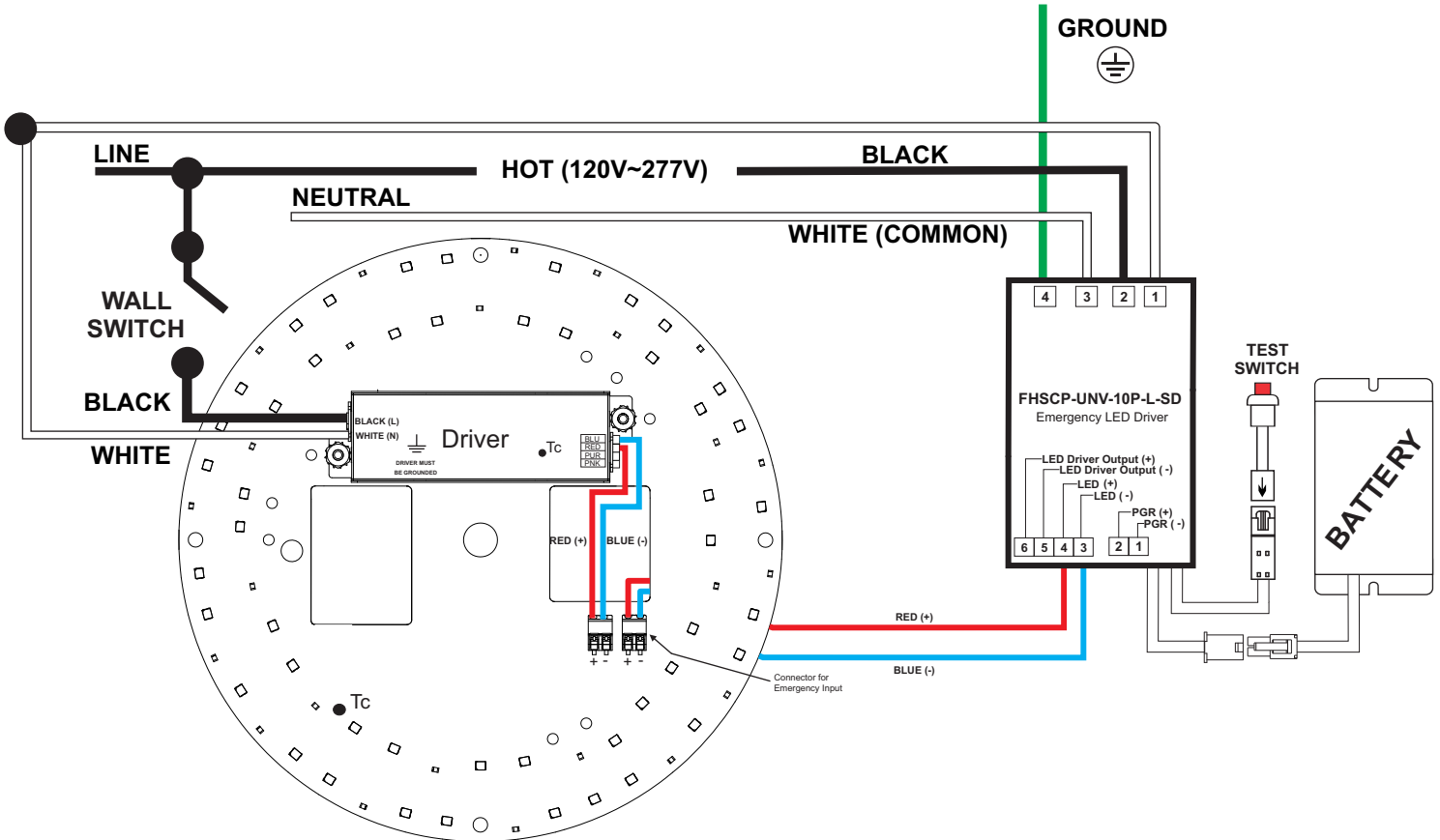

NOTES:

- 1) For reference only, several factors apply.
- 2) Emergency systems are not UL classified for field installation.

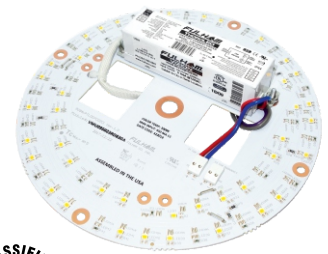

VKMUNV018RDxxxA



Color and Binning

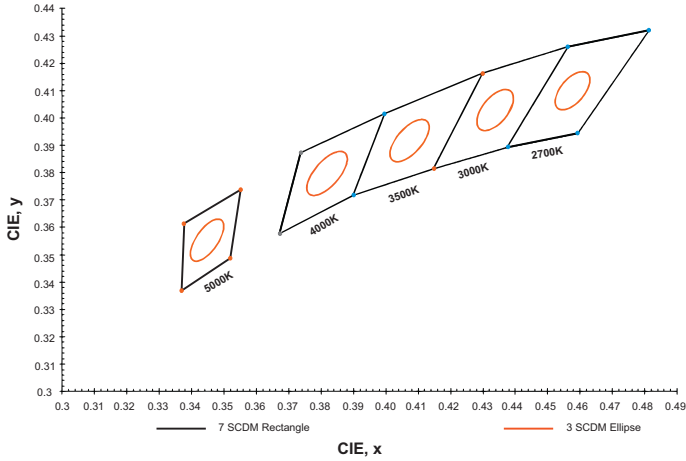

Optical Spectrum

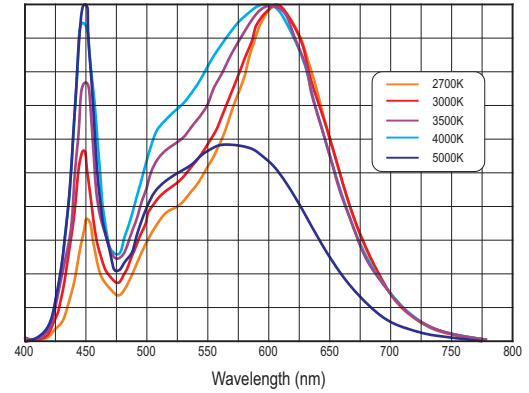

NOTES:

- 1) The Color and Binning and Optical Spectrum charts are for reference only. For more detailed info, contact factory.
- 2) Reference Samsung Chromaticity Diagram for Color and Binning. Binning per ANSI C78.377-2015 @ 25°C; 3 SDCM.
- 3) The Optical Spectrum values vary depending on product type and color rank.

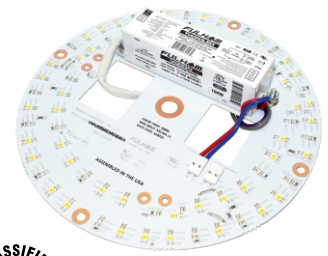

VKMUNV018RDxxxA

Guidelines

Reduced Flicker Operation Feature

- DC Engine models have added circuitry to help reduce the Flicker when operated on the 50/60Hz power lines. The Flicker percentage on these models is below 30% when operated at line voltage, per CEC requirement.

Termination Notes

- A luminaire disconnect UL listed connector is included, as part of DC Engine Retrofit Kit to meet Energy Star requirements.
- Use solid wire size 18AWG/12" per pole, rated at max 600V load and 105°C operating temperature.
- Strip wires to 11-13mm (0.47in.).
- Connector not for multiple use.
- For additional information on Wago's 873 Series Lumi-Nuts® connector, please visit: http://www.wago.com/infomaterial/wago_ebook/51261593/flipviewerexpress.html



Environmental Rating

- DC Engine Retrofit Kit are rated for dry and damp locations.

Fastening to Luminaire

- When installing by "mounting thru holes" (recommended), use any screw with diameter less than 0.13in. [3.4mm]. Mount on a flat surface and use all 4 mounting holes to ensure good contact between back side of DC Engine Retrofit Kit and mounting surface. Refer to max specified torque for installation. Suggested screw sizes: #5 or M3 Pan Head screw.

Electrostatic Sensitive Product (ESD)

- Fulham LED products should be handled with proper measures to protect against any potential ESD damage.
- When servicing, personnel should be ground and direct contact with LED should be avoided.

Thermal Management

- Proper thermal management should be employed to ensure life and reliability of product.

Wiring

- Intended for UNV (120-277V) application ONLY.
- Connect the Black wire from the DC Engine Retrofit Kit to the building Line by using the proper connectors or wire nuts.
- Connect the White wire from the DC Engine Retrofit Kit to the building/source Neutral by using the proper connectors or wire nuts.
- DC Engine Retrofit Kit and luminaire must be grounded.



VKMUNV018RDxxxA



Part Number Matrix

V **K** **M** **UNV** **018** **RD** **8** **40** **A**

Product Line
 V = Vizion [Ⓢ]K = DC Engine Retrofit Kit (cULus Classified)

Compliance
 M = 0-10V

Dimming
 UNV = 120V~277V

Input Voltage
 018 = 18W

Estimated Power
 RD=Round

Shape
[Ⓢ]8 = 80 [Ⓢ]9 = 90

CRI
[Ⓢ]27 = 2700K
[Ⓢ]30 = 3000K
[Ⓢ]35 = 3500K
[Ⓢ]40 = 4000K
[Ⓢ]50 = 5000K
[Ⓢ]57 = 5700K
[Ⓢ]65 = 6500K

Color Temperature
[Ⓢ]A = CEM1

Material

- [Ⓢ] Standard Product offering, in addition to 90CRI / 3000K. (All other options are made to order with MOQ and lead time).
- [Ⓢ] DC Engine Retrofit Kit includes mounting hardware, retrofit labels, and installation instructions.

Product Image: 18W Round DC Engine Retrofit Kit

VKMUNV018RDxxxA

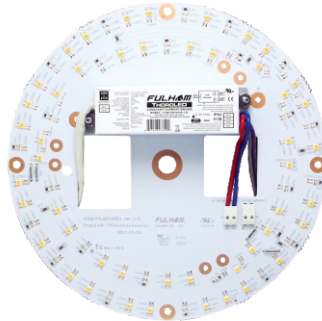

This luminaire has been modified and can no longer operate the originally intended lamp. Ce luminaire a été modifié et ne peut plus utiliser la lampe prévue à l'origine.

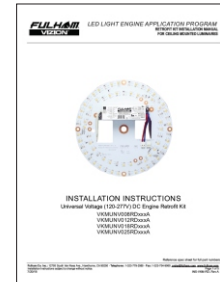

Hardware Kit: TLC-HW08

UNV DC Engines Retrofit Kits with 0-10V Dimming :
 Hardware, Quick disconnect, Labels & Installation Instructions

Packaging

Master Carton

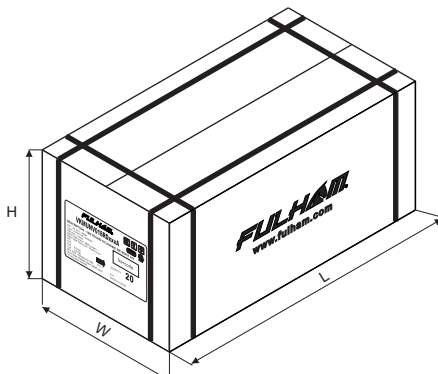

OUTER DIMENSION		
L	W	H
21.65"(550mm)	15.75"(400mm)	9.45"(240mm)
Net Weight	Gross Weight	QUANTITY
14.52 lbs. (6.6 kg)	20.24 lbs. (9.2 kg)	20pcs.