

L05031 LED Driver 30W, 6-42 Vdc, 100 - 1400 mA L1W1MID140S-30E

Engineered for Best Fixture Performance

Fulham LumoSeries drivers are all built on core engineering design principles for exceptional standards of performance and reliability in LED systems. Highest-grade critical components together with design features for thermal management ensure excellent reliability. Our low ripple designs create flicker-free lighting and perfectly smooth dimming. Simplicity of specification and installation is a key characteristic of all Fulham LumoSeries drivers. Hence the wide voltage and current ranges and industry leading low inrush current.



A versatile driver with small form factor and a wide voltage Output range ideally suited for COB arrays and LED strips.



Engineered for Performance

- Industry leading efficiency
- Excellent EMC behavior
- Very high power factor
- Hot swapping of LEDs > 10W

Engineered for Reliability

- Thermal protection (automatic current limiter)
- Short and open circuit protection, overload and overvoltage protection

Engineered for Simplicity

- High quality low cost product with low inrush current and high efficiency
- The L05031 has “automatic dim mode detection”.
This implies that the driver automatically detects any change to the dim input.
The driver will automatically detect whether a puls switch, potentiometer or 0/1-10V is connected. The dimming function is stored in the driver.

5 year warranty

Fulham LumoSeries takes pride in the quality of its products. We not only develop all products in house, they are also produced to ensure guaranteed reliability and performance. Fulham LumoSeries drivers come with the assurance of a 5 year warranty. After all, with typical LED lifetimes of 50,000 hours, it is critical to have a power supply with equal reliability.



Product features

- Wide output voltage range 6 - 42 Vdc
- Wide range of current settings 100 - 1400mA
- 0-10V-, 1-10V-, potentiometer- and pulse dimming
- Zero ripple current
- Automatic dim mode detection
- Suitable for warm dimming (natural toning/ dim-to-warm) LEDs
- Max inrush current 0.88 A
- Dual stage topology
- Thermal protection: dimming instead of switching off
- Open circuit output voltage protection
- Up to 88 % efficiency across a wide range of loads
- Power factor 0.97
- ENEC certified
- Engineered and Manufactured in Europe
- SELV

Certificates and standards

- ENEC05, CE
- EN55015 / EN61000-3-2 / EN61347-2-13 / EN61347-1 / EN61547 / EN62384 / SELV

Classifications



Specific technical data

Type	Efficiency at full load	Output current	Output voltage range	Open circuit output voltage	Max. output power	Dimming
L05031	88 %	100 - 1400 mA	6 - 42 Vdc	48 Vdc	30 W	0-10V,1-10V, potentiometer or Pulse (SELV)

Technical data

Rated supply voltage	220-240 Vac
Input voltage	180-240 Vac / 150-375 Vdc*
Mains frequency	50/60 Hz
Output current tolerance	5%
100 Hz ripple current	<1%
Power factor at full load	0.97
Standby power	350 mW
Nominal line current at 240 Vac	160 mA
Dimming method	linear
Minimum dim level	15 mA
Nonvolatile memory	Yes
Startup time	< 1s
Warm up time to 95% of light output	< 1s
Output isolation	SELV
Surge protection (diff. / comm.)	2 kV / 6 kV
IP classification	IP 20
Circuit lifetime	50,000 hrs at Tc max.
Case dimensions	110 x 52 x 23.5 mm
Case material	Polyamide 6 (PA6)

* External DC fuse is required

Dimensions

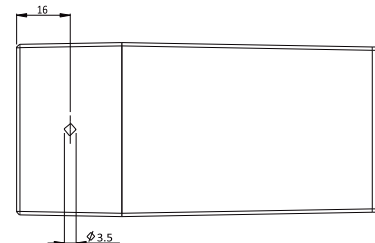
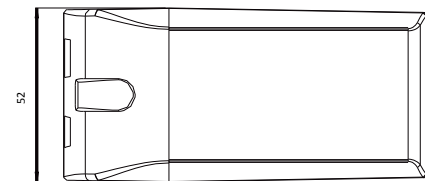
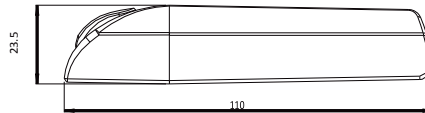

Inrush current

Mains max. peak inrush at full load	0.255A per driver on phase 60° (average starting angle)*
	0.851A per driver on phase 90° (worst case starting angle)*
	0.321A per driver on phase 60° (average starting angle)**
	0.879A per driver on phase 90° (worst case starting angle)**

** Tested at 240 Vac 1 driver connected, with TTI HA1600A analyzer.

* Tested at 240 Vac 10 drivers parallel connected, with TTI HA1600A analyzer.

Maximum number of drivers on automatic circuit breakers

Automatic circuit breaker type	C10	C13	C16	C20	B10	B13	B16	B20
L05031	59	76	94	117	59	76	94	117

Thermal specifications

Ambient temperature range (Ta)	-20 to 45°C
Maximum case temperature (Tc)	< 80°C
Storage temperature range	-20 to 50°C

Over temperature protection

The LED driver is protected against thermal overload. If the temperature limit is exceeded, the output current is reduced.

Active overload protection

If the maximum output power is exceeded, the LED driver reduces the LED output to a current level within the specifications of the driver. This prevents overload at all times.

No-load operation

In no-load operation the output voltage will not exceed the specified open circuit output voltage.

Unexpected behavior when using 0-10V/ 1-10V

When controlling the driver with a 0-10V/ 1-10V system it can occur that the 0/1-10V controller delivers (or allows) a voltage that is higher than 12V. The voltage triggers the driver in to 'pulse switch mode'. This will result in unexpected and unintended behavior of the LED's. In case of symptoms like these, it is sufficient to clamp the output of the control system with a 10 or 12V zener diode. (cathode to the positive).

To prevent this from happening always use a system / dimmer which complies with EN60929 Annex E.

Short-circuit protection

In case of a short circuit the LED driver switches to protection mode. After the removal of the short-circuit the LED driver will recover automatically.

Mounting/ Cooling

Above an output power of 25W, the driver needs to be mounted on a heat conductive surface of at least 200cm² Always test if the surface is sufficient before installing the driver.

Active overcurrent protection

Active overcurrent protection to allow hot swapping of LEDs higher than 10 Watt.

LED load

Fulham LumoSeries LED drivers are designed to drive passive LEDs, -COB's and LED assemblies

Proper function is not guaranteed when (LED)loads with active components are used.

Wiring diagram

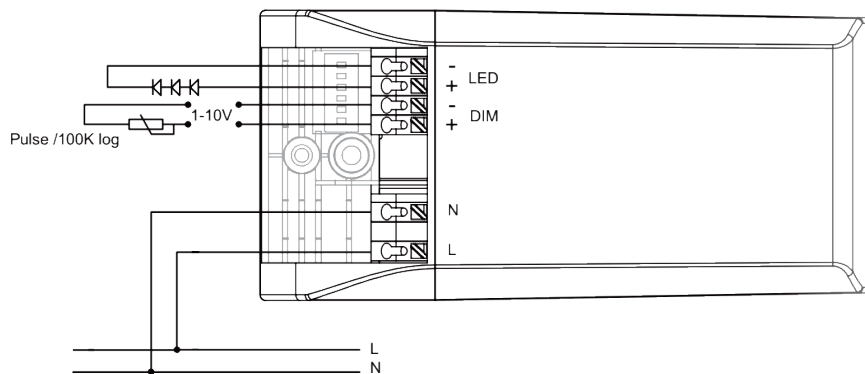

Wiring of device

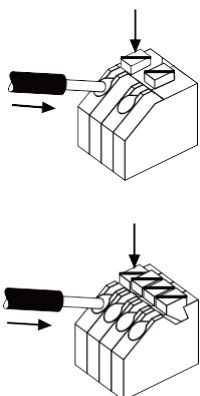

Solid

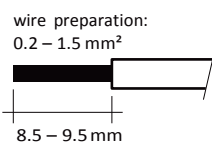

Stranded

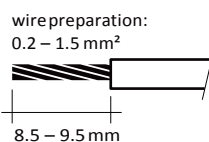
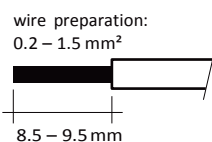
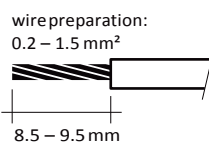

Strain relief

The strain relief inserts can be removed to accommodate wiring of larger diameters.

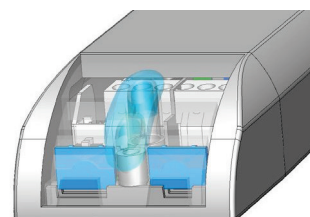

Dipswitch settings

The current settings can be adjusted by using the dipswitches on the driver. The table lists the supported currents.

The switch in the up position (ON) is defined as '1'.

The switch in the down position (OFF) is defined as '0'.

The examples below illustrate two settings for the L05031



L05031 dipswitch settings

Output current (mA)	max output power (W)	Switch no					
		1	2	3	4	5	6
reserved		0	0	0	0	0	0
100	4	1	0	0	0	0	0
120	5	0	1	0	0	0	0
140	6	1	1	0	0	0	0
160	7	0	0	1	0	0	0
180	8	1	0	1	0	0	0
200	9	0	1	1	0	0	0
220	9	1	1	1	0	0	0
240	10	0	0	0	1	0	0
260	11	1	0	0	1	0	0
280	12	0	1	0	1	0	0
300	13	1	1	0	1	0	0
320	14	0	0	1	1	0	0
340	15	1	0	1	1	0	0
360	15	0	1	1	1	0	0
380	16	1	1	1	1	0	0
400	17	0	0	0	0	1	0
420	18	1	0	0	0	1	0
440	19	0	1	0	0	1	0
460	20	1	1	0	0	1	0
480	21	0	0	1	0	1	0
500	22	1	0	1	0	1	0
520	22	0	1	1	0	1	0
540	23	1	1	1	0	1	0
560	24	0	0	0	1	1	0
580	25	1	0	0	1	1	0
600	26	0	1	0	1	1	0
620	27	1	1	0	1	1	0
640	28	0	0	1	1	1	0
660	28	1	0	1	1	1	0
680	29	0	1	1	1	1	0
700	30	1	1	1	1	1	0
720	30	0	0	0	0	0	1
740	30	1	0	0	0	0	1
760	30	0	1	0	0	0	1
780	30	1	1	0	0	0	1
800	30	0	0	1	0	0	1
820	28	1	0	1	0	0	1
840	28	0	1	1	0	0	1
860	28	1	1	1	0	0	1
880	28	0	0	0	1	0	1
900	28	1	0	0	1	0	1
920	28	0	1	0	1	0	1
940	28	1	1	0	1	0	1
960	28	0	0	1	1	0	1
980	28	1	0	1	1	0	1
1000	28	0	1	1	1	0	1
1020	28	1	1	1	1	0	1
1040	28	0	0	0	0	1	1
1060	26	1	0	0	0	1	1
1080	26	0	1	0	0	1	1
1100	26	1	1	0	0	1	1
1120	26	0	0	1	0	1	1
1140	26	1	0	1	0	1	1
1160	26	0	1	1	0	1	1
1180	26	1	1	1	0	1	1
1200	26	0	0	0	1	1	1
1220	26	1	0	0	1	1	1
1240	26	0	1	0	1	1	1
1260	26	1	1	0	1	1	1
1280	26	0	0	1	1	1	1
1300	26	1	0	1	1	1	1
1350	26	0	1	1	1	1	1
1400	26	1	1	1	1	1	1

Warm dimming

The L05031 uses the linear dimming method instead of PWM. Therefore, the driver is suitable for warm dimming / dim-to-warm / Natural toning / sunset dimming / warm glow dimming.

0/1-10V dimming

In case of multiple drivers on one dimmer, make sure that the wires are connected according to polarity. Each driver supplies the 0/1-10V dimming bus with 1mA max. (50mA sink capable dimmer can dim 50 drivers). Only dimmers with a minimum class II protection may be used.

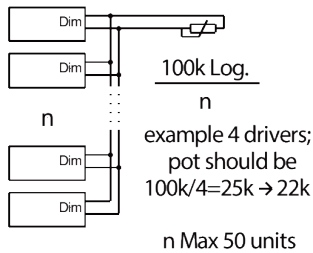

Pulse dimming

In case of multiple drivers on one dimmer, make sure that the wires are connected according to polarity

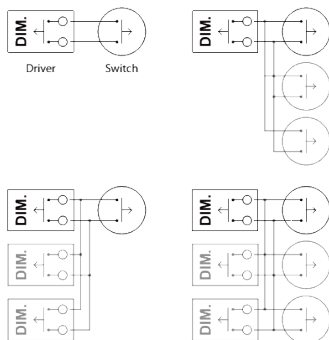

Ordering data

Part	Part number	Alternate part number	EAN code	Packaging carton	Multibox carton	Weight per piece
L05031 LED Driver 30W 100 - 1400mA	L05031	L1W1MID140S-30E	8718801703595	20 pieces	240 pieces	130g

Berenkoog 56
NL-1822 BZ Alkmaar
The Netherlands

www.Fulham.com

© 2017, Fulham Company All rights reserved. Designs and specifications may change without prior notice. Fulham products are not designed, intended, or authorized for any application in which the failure of the product could cause personal injury.

Formerly Lumotech.