



INSTALLATION INSTRUCTIONS

1X4 Vapor Tight Retrofit Kit

VR44-MU-295-xyy-1400Z

VR44-MU-295-xyy-1050Z

VR44-MU-295-xyy-0700Z

VR44-MU-195-xyy-0700Z

1.0 INSTALLATION WARNINGS

1. "THIS PRODUCT MUST BE INSTALLED IN ACCORDANCE WITH THE APPLICABLE INSTALLATION CODE BY A PERSON FAMILIAR WITH THE CONSTRUCTION AND OPERATION OF THE PRODUCT AND HAZARDS INVOLVED."
2. "WARNING - Risk of fire or electric shock. LED Retrofit kit installation requires knowledge of luminaire electrical systems. If not qualified, do not attempt installation. Contact a qualified electrician."
3. "WARNING - Risk of fire or electric shock. Install this kit only in the luminaire that has the construction features and dimensions shown in the photographs and/or drawings and where the input rating of the retrofit kit does not exceed the input rating of the luminaire."
4. "WARNING - To prevent wiring damage or abrasion, do not expose wiring to edges of sheet metal or other sharp objects."
5. "WARNING –Risk of fire or electric shock. Luminaire wiring and electrical parts may be damaged when drilling for installation of LED retrofit kit. Check for enclosed wiring and components."
6. "CAUTION – RISK OF FIRE. CONSULT A QUALIFIED ELECTRICIAN TO ENSURE CORRECT BRANCH CIRCUIT CONDUCTOR."
7. "THE RETROFIT KIT IS ACCEPTED AS A COMPONENT OF A LUMINAIRE WHERE THE SUITABILITY OF THE COMBINATION SHALL BE DETERMINED BY THE AUTHORITIES HAVING JURISDICTION."
8. Do not make or alter any open holes in an enclosure of wiring or electrical components during kit installation.

1.0 AVERTISSEMENTS D'INSTALLATION

1. CE PRODUIT DOIT ÊTRE INSTALLÉ SELON LE CODE D'INSTALLATION PERTINENT, PAR UNE PERSONNE QUI CONNAÎT BIEN LE PRODUIT ET SON FONCTIONNEMENT AINSI QUE LES RISQUES INHÉRENTS.
2. AVERTISSEMENT - Risque d'incendie ou de choc électrique. L'installation de ce nécessaire de modernisation exige une personne familière avec la construction et le fonctionnement du système électrique du luminaire et des risques associés. Toute personne qui n'est pas qualifiée ne doit faire aucune tentative d'installation et doit contacter une personne qualifiée.
3. AVERTISSEMENT - Risque d'incendie ou de choc électrique. N'installer ce nécessaire que dans les luminaires dont les caractéristiques de construction et les dimensions sont conforme à celles illustrées dans les photos et/ou les dessins et dont la puissance d'entrée nominale du nécessaire de modernisation ne dépasse pas celle du luminaire.
4. AVERTISSEMENT - Afin de prévenir l'endommagement ou l'abrasion des câbles, éviter tout contact entre ces derniers et le bord d'un objet tranchant tel qu'une tôle.
5. "AVERTISSEMENT -Risk d'incendie ou de choc électrique. Le câblage du luminaire et les pièces électriques peuvent être endommagés lors du forage pour l'installation d'un kit de reconditionnement LED. Vérifiez le câblage et les composants inclus. "
6. ATTENTION – RISQUE D'INCENDIE, CONSULTER UN ÉLECTRICIEN QUALIFIÉ POUR VOUS ASSURER QUE LES CONDUCTEURS DE LA DÉRIVATION SONT ADÉQUATS.
7. LE NÉCESSAIRE DE MODERNISATION EST ACCEPTÉ À TITRE DE COMPOSANT D'UN LUMINAIRE LORSQUE LA PERTINENCE DE LA COMBINAISON DOIT ÊTRE DÉTERMINÉE PAR LES AUTORITÉS COMPÉTENTES.
8. Ne faites pas ou ne modifiez aucun trou ouvert dans une enceinte de câblage ou de composants électriques pendant l'installation du kit

2.0 ORIGINAL LUMINAIRE DIMENSIONS

Original Luminaire
 (Shat-R-Shield: VT42300)



Minimum Luminaire Dimensions

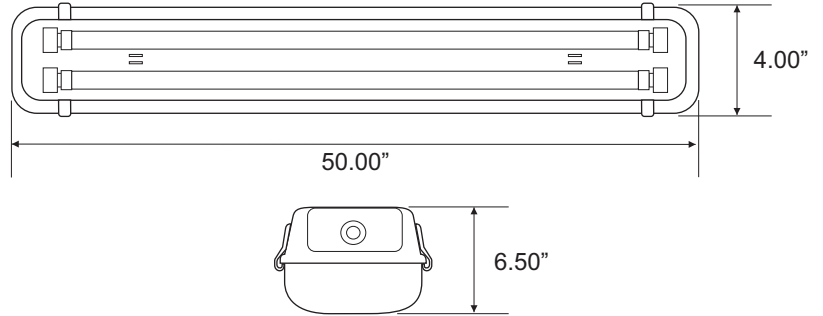

- Remove all the original luminaire parts, hardware, lamp, and ballast in order to begin the retrofit.
- Original luminaire diffuser and original ground wire will need to be kept for this retrofit.
- This Kit can be retrofitted into any luminaire with a similar length/height width greater than or equal to the Minimum Luminaire Dimensions described above.

3.0 RETROFIT KIT COMPONENTS

Retrofit kit components will be provided as listed below:



LED Modules



LED Diffuser Lens
(Optional)



LED Diffuser End Caps
(Optional)



LED Driver



LED Harness



Mounting Hardware

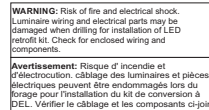

Retrofit Warning Label



Name Plate Label

4.0 RECOMMENDED TOOLS (Not Included)

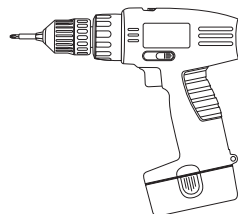

Power Drill W/ Philips Bit

5.0 RETROFIT KIT DESCRIPTION

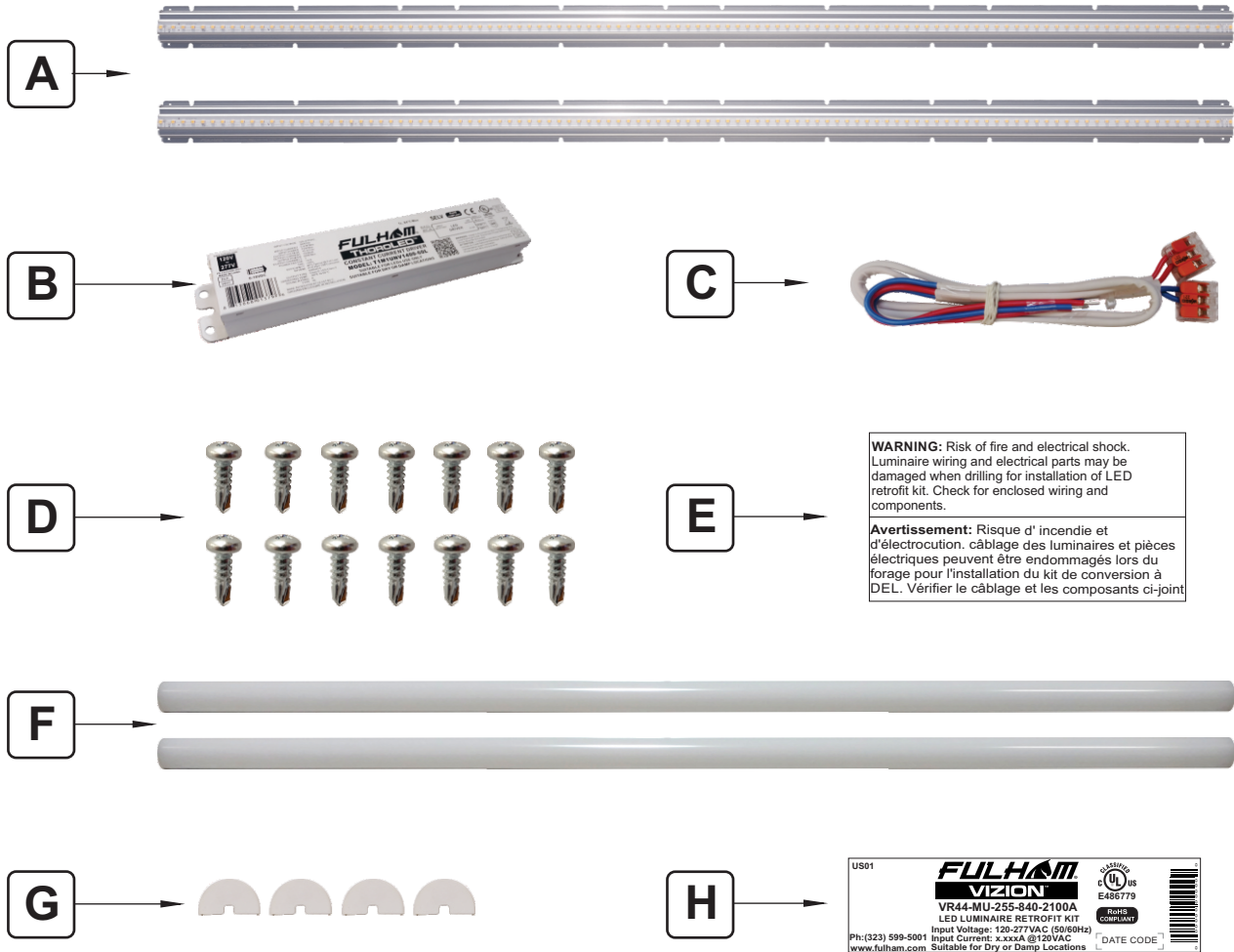

ITEM	DESCRIPTION	QTY
A.	LED Modules	*2
B.	LED Driver(Varies by model)	1
C.	LED Harness: TLC-HN02	1
D.	6-20 X 3/8" Pan Head Self Drilling Screws	*14
E.	Retrofit Warning Label	1
F.	LED Module Lens: TLE-OPT120-013 (Optional)	*2
G.	LED Module Lens End Caps:TLE-OPT-120-020 (Optional)	*4
H.	Name Plate Label	1

*Note: Item quantity will vary based on retrofit kit model purchased. Please refer to retrofit kit spec sheet for more details.

6.0 ORIGINAL LUMINAIRE DISASSEMBLY

1. Start by removing the Lens from the luminaire. See Picture #1.

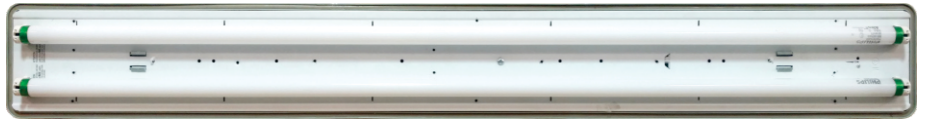

Picture #1

2. Remove the lamps, lamp sockets and ballast from the luminaire. See Picture #2 and #3.



Picture #2

3. The original ground wire will need to be kept for this retrofit.

Luminaire should look like Picture #3 in order to begin the retrofit.



Picture #3

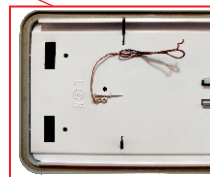

7.0 RETROFIT KIT ASSEMBLY

1. Start by Placing the LED Modules (A) onto the luminaire mounting plate as shown on Figure 1.

Note: If kit includes LED Module Lens install the LED Module Lens before placing the LED Module onto the Luminaire.

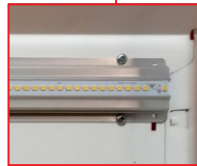

Figure 1

2. Secure the LED Modules to the luminaire mounting plate using the provided 6-20 x3/8" Pan Head Self Drilling Screws (D). See Figure #1.



LED module with lens installed



3. Affix the Retrofit Warning Label (E) in the area where it can be visible during the LED Driver installation. See Figure 2.

4. Place the LED Driver (B) onto the luminaire mounting plate on the location shown on Figure 2.

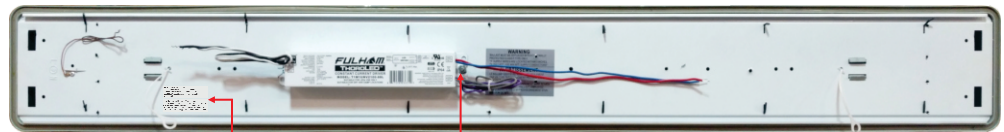
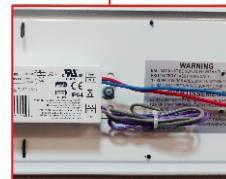

Figure 2

5. Secure the LED Driver (B) to the luminaire mounting plate using the original screw. If the original screw is not available, use the provided 6-20 x 3/8" Pan Head Self Drilling Screws (D). See Figure 2.



WARNING: Risk of fire and electrical shock. Luminaire wiring and electrical parts may be damaged when drilling for installation of LED retrofit kit. Check for enclosed wiring and components.
Avvertimento: Rischio di incendio e di elettrocuzione, cablaggio dei luminari e pezzi elettronici possono essere danneggiati lors du forage pour l'installation du kit de conversion a DEL. Verifier le cablage et les composants ci-joint.

6. Wire the LED driver output wires to LED module input connectors using the provided LED Harness (C). See Figure 3.

7. Wire the LED driver input wires to the power source. See Figure 3 and refer to the Connecting Power To The Retrofit Kit section of Page 7 for appropriate wiring instructions.



Figure 3

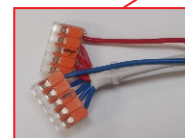
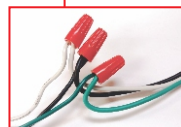

7.0 RETROFIT KIT ASSEMBLY

8. Place the provided Name Plate Label (H) on the luminaire mounting plate in a readily visible location on the luminaire. See Figure 4-A.

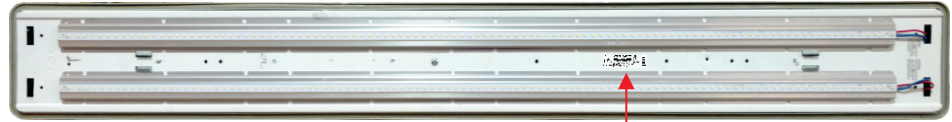

Figure 4 - A

9. Place the luminaire mounting plate back onto the luminaire and replace the luminaire lens. See Figure 4-A and Figure 5.

Note: if kit included Module Lens then the completed retrofit should look like Figure 4-B and Figure 5.



Figure 4 - B

10. Completed retrofit should look like Figure 5.



Figure 5

Connecting Power to the Retrofit Kit:

- 1) Connect the green wire (Ground) from the luminaire to the Ground that is being fed by the power source. Connect these two wires by using a wire connector with a minimum 18AWG rating.
- 2) Connect the white wire (Neutral) from the LED Driver to the Neutral being fed by the power source. Connect these two wires by using a wire connector with a minimum 18AWG rating.
- 3) Connect the Black wire (Line) from LED Driver to the Line being fed by the power source. Connect these two wires by using a wire connector with a minimum 18AWG rating.

8.0 WARRANTY

- Please refer to LinearHO kit spec sheet for warranty information