

- Thoro LED Driver
- U-OUT 24V
- Dry or Damp
- Suitable for Class I luminaire
- Universal Voltage: 100-277V~, 50/60Hz
- Output Voltage: 24V=
- Output Power: 20W
- Output Current: 833mA Max.
- 0-10V Dimming

### This Driver Will Operate The Following LED Modules:

Any LED module designed to accept constant voltage input up to 24VDC and has a maximum current of 833mA.  
 Note: Constant voltage modules are usually with on-board circuit besides LEDs, the module & driver compatibility check is preferred before any installation. Some of the modules with big input capacitance may lead to the incompatibility with the dimmable driver, contact Fulham for further assistance.

### General Specifications

Input Voltage	100-277V~, 50/60Hz
Input Current	0.25A @100VAC, 0.095A @277VAC
Power Factor	>0.9
THD	<20%
Efficiency	>80% Typical@277V Full Load
Driver Type	Constant Voltage
Output Voltage Range	24V=
Output Current	833mA
Output Power	20W
Number of Output Channels	1 Channel
Dimming Controller Type/Dimming Range	0-10VDC / 100%-10%
RFI/EMI	FCC Part 15B Consumer, EN55015
Output Type	Class 2
Sound Rating	A
Input Surge Protection	Line-Neutral 1kV, Line & Neutral-Ground 2kV
Protections	Current Protection Output to Ground Short Protection Output Short Circuit Protection Output Open Circuit Protection Overload Protection
Max. Case Temperature	90°C(194°F)
ta	-20°C to 73°C(-4°F to 163.4°F)
Service Life	50,000 hours @Tc 77.5°C(171.5°F)
Approvals / Class	CE, cURus, Class2, RoHS, Dry or Damp Locations, Type HL
Warranty	5 years

Figure 1

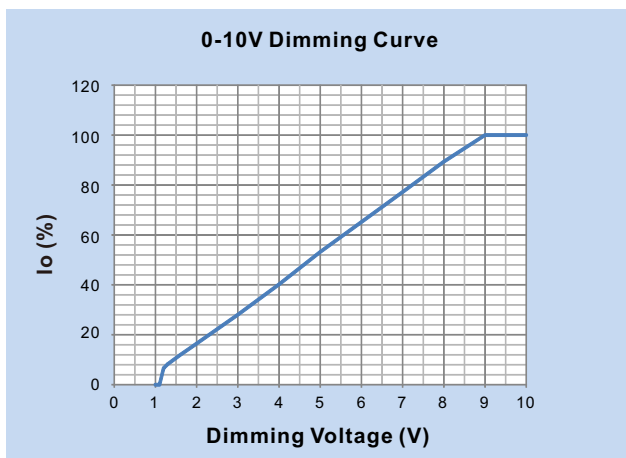
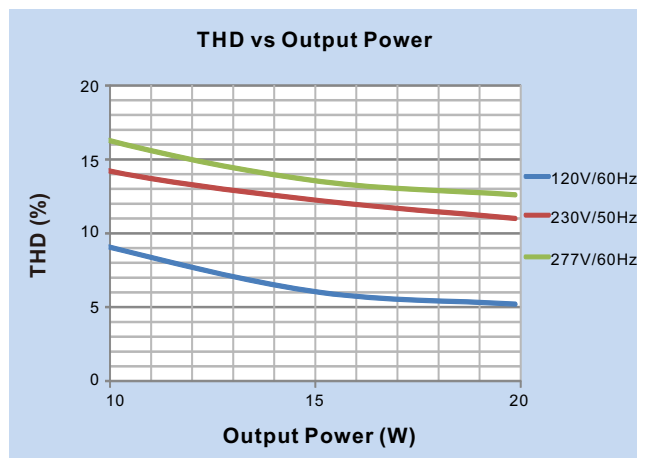

Figure 2



Fulham extends a limited warranty to the original purchaser or first user for a period of 5 years @ Tc 77.5°C from the date of manufacture when properly installed and operated under normal conditions of use. For complete terms and conditions, please refer to the Warranty Center at [www.fulham.com](http://www.fulham.com). Specifications subject to change without notice.

Figure 3

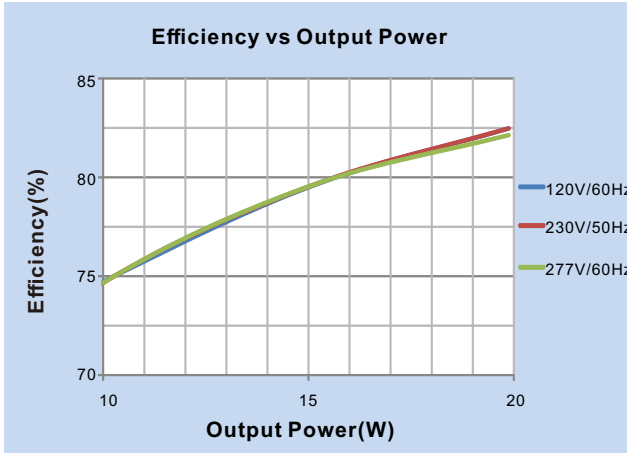

Figure 4

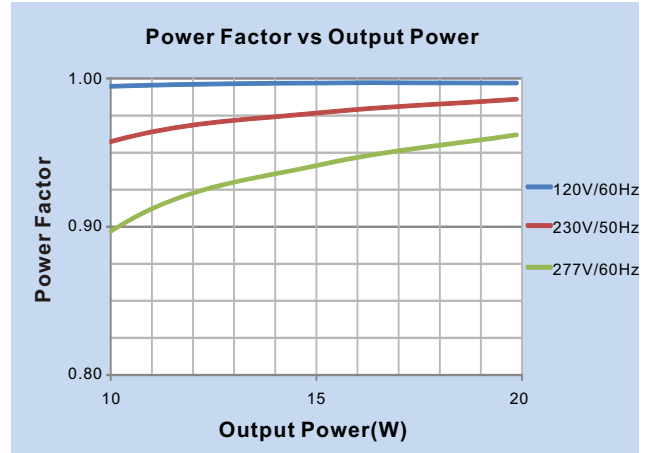
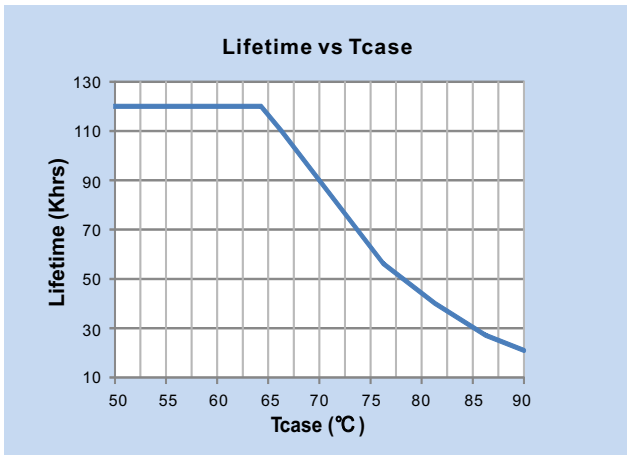
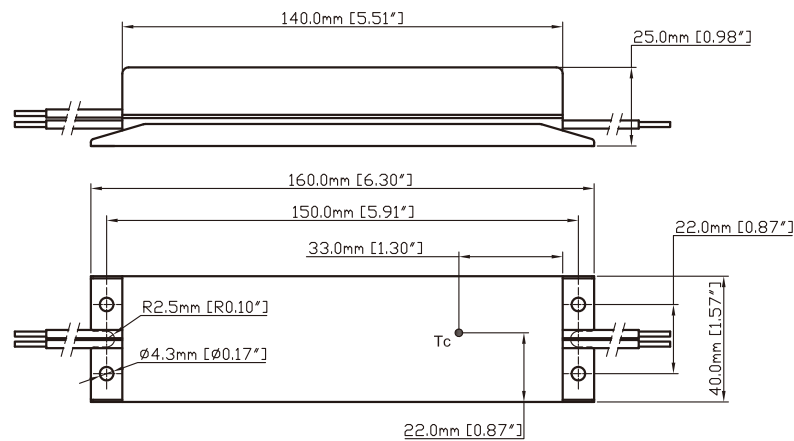

Figure 5



### Mechanical Data

LENGTH	WIDTH	HEIGHT
160mm	40mm	25mm
6.30"	1.57"	0.98"



Case Tolerance= $\pm 0.02$ "

Fulham extends a limited warranty to the original purchaser or first user for a period of 5 years @ Tc 77.5°C from the date of manufacture when properly installed and operated under normal conditions of use. For complete terms and conditions, please refer to the Warranty Center at [www.fulham.com](http://www.fulham.com). Specifications subject to change without notice.

**Wiring Diagrams**

INPUT SIDE	LENGTH
PURPLE	150mm [6"]
PINK	150mm [6"]
WHITE	150mm [6"]
BLACK	150mm [6"]

OUTPUT SIDE	LENGTH
RED	150mm [6"]
BLUE	150mm [6"]

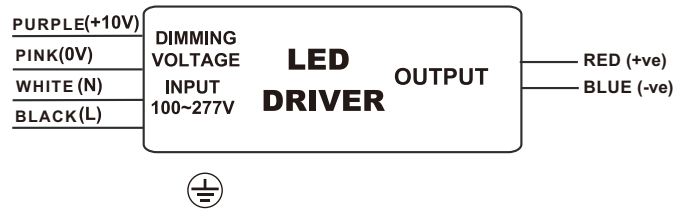

Note: Pink or Gray dimming wire provided. use interchangeably.

**NOTE :**

- 1.This Driver Must Be Installed By A Licensed Electrician
- 2.This Driver Must Be Grounded